



# VW Crafter 2017-

Art. 840806

Töötulede laternakanduri montaažikomplekt | Lamp holder for working lights, mounting kit | Носител фар рабочего освещения, монтажный комплект | Scheinwerferbügel für arbeitsleuchten, Montagesatz



- |                                                                                             |    |
|---------------------------------------------------------------------------------------------|----|
| 1. Laternaklamber / clamp for lamp / зажим для лампы / Schelle                              | 2  |
| 2. Klamber / clamp / зажим / Schelle                                                        | 4  |
| 3. Kronstein / bracket / кронштейн / Konsole                                                | 2  |
| 4. Kronstein / bracket / кронштейн / Konsole                                                | 2  |
| 5. Kronstein / bracket / кронштейн / Konsole                                                | 2  |
| 6. Magnetkinnitus / magnetic fastening / магнитное крепление / Magnetbefestigung d=66 M8x15 | 2  |
| 7. Kummiseib / rubber washer / резиновая шайба / Gummisscheibe                              | 2  |
| 8. Kummiseib / rubber washer / резиновая шайба / Gummisscheibe d=30/5                       | 2  |
| 9. Kummiseib / rubber washer / резиновая шайба / Gummisscheibe d=25/ 5                      | 2  |
| 10. Polt / bolt / болт / Bolzen M8x25                                                       | 12 |
| 11. Polt / bolt / болт / Bolzen M6x30                                                       | 2  |
| 12. Mutter / nut / гайка / Mutter M8                                                        | 14 |
| 13. Mutter / nut / гайка / Mutter M6                                                        | 2  |
| 14. Seib / washer / шайба / Scheibe 8,4x24x2                                                | 26 |
| 15. Seib / washer / шайба / Scheibe 6,6x22x2                                                | 4  |

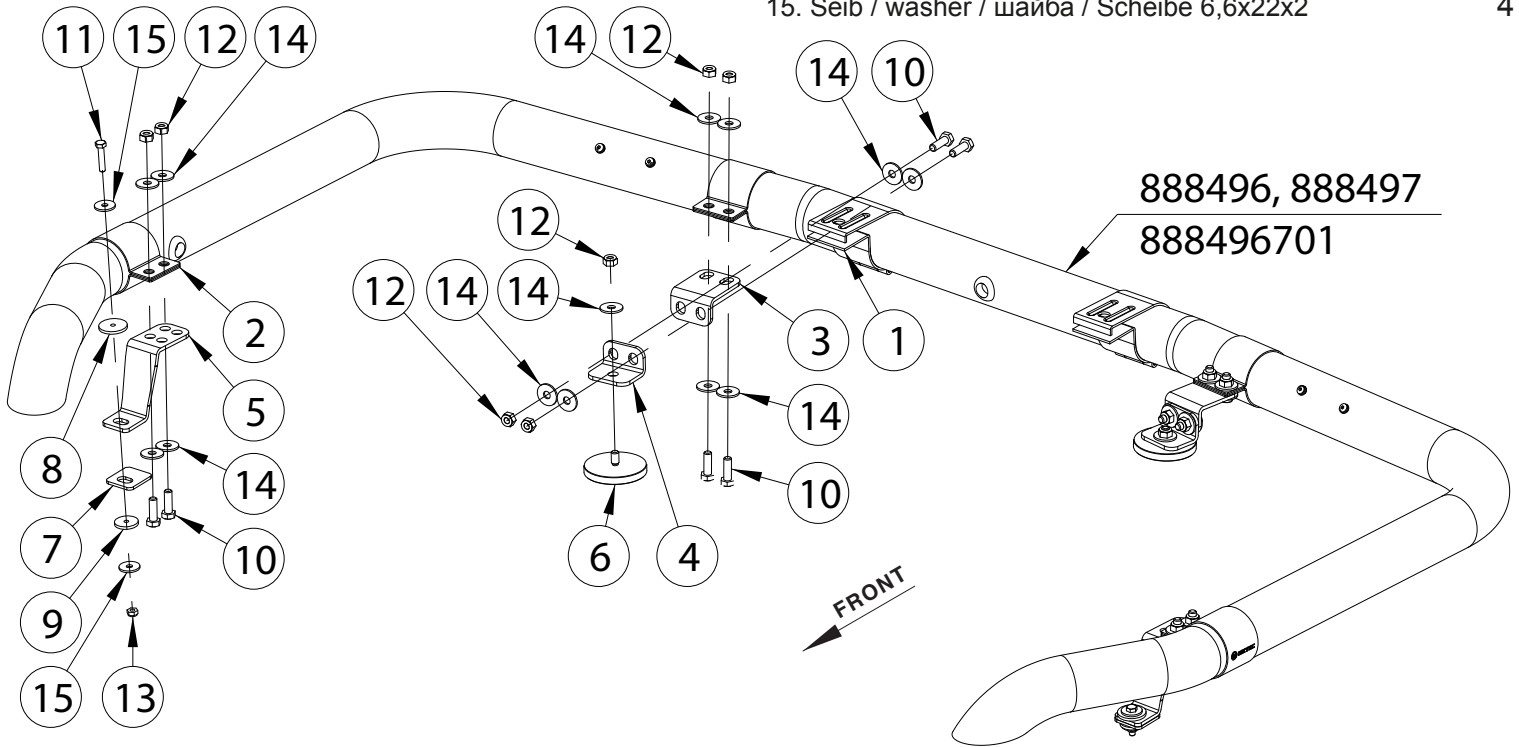

Kaal / Weight / Масса / Gewicht: 11,3 kg (888496), 10,3 kg (888497)  
Paigaldusaeg / Time of mounting / Время установки / Einbauzeit: 60 min

Vajalikud tööriistad / Required Tools / Необходимые инструменты / Benötigte Werkzeuge

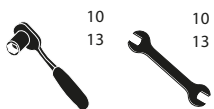

**M6 - 11 Nm**  
**M8 - 25 Nm**

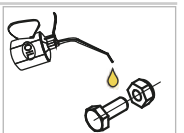

# VW Crafter 2017-

Töötulede laternakanduri montaažikomplekt | Lamp holder for working lights, mounting kit | Носител фар рабочего освещения, монтажный комплект | Scheinwerferbügel für arbeitsleuchten, Montagesatz

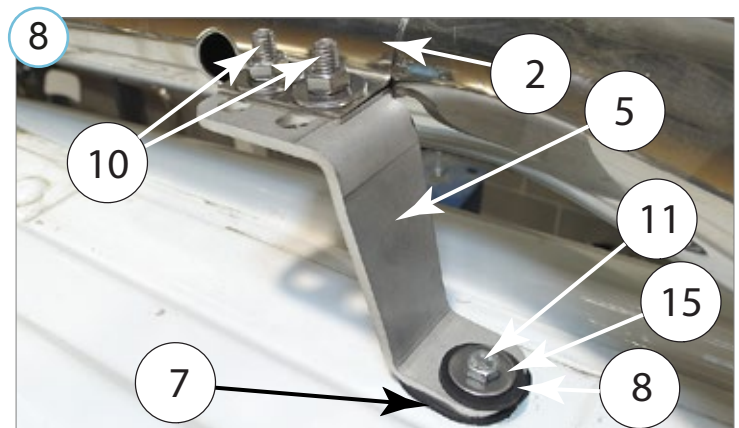
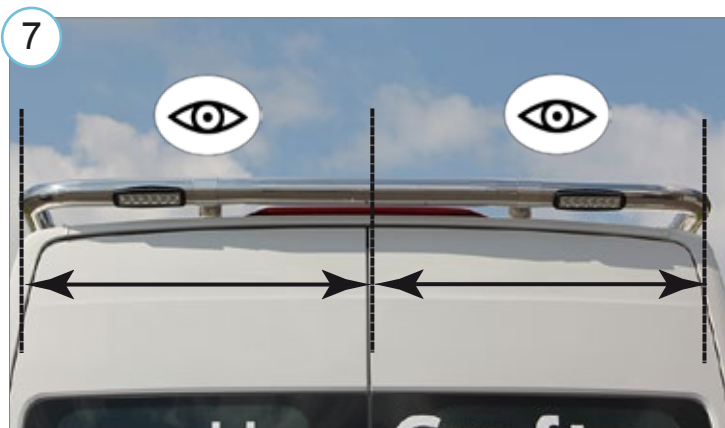
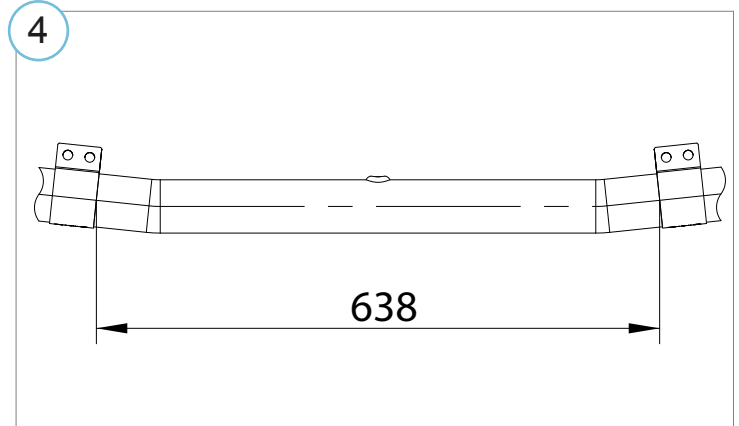
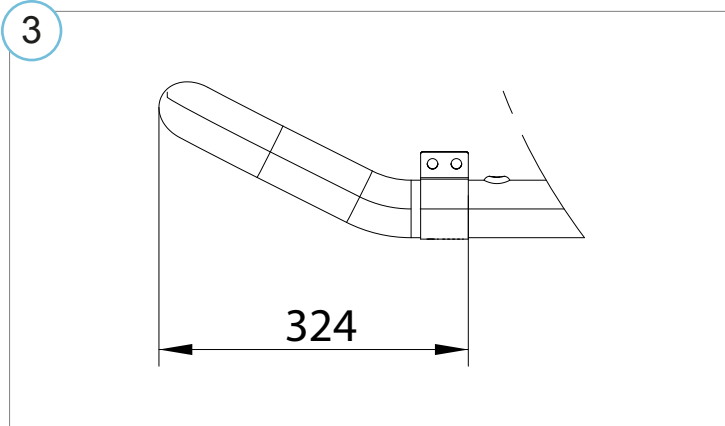
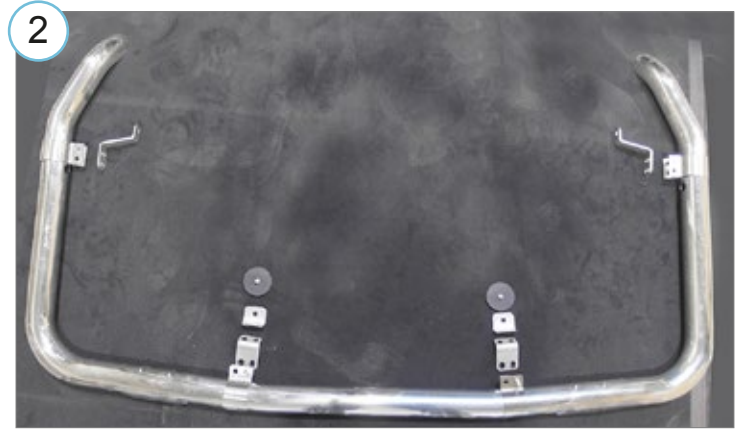
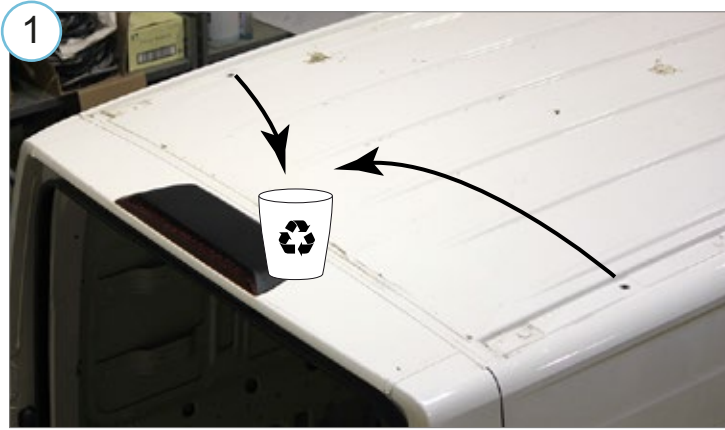



# VW Crafter 2017-

Töötulede laternakanduri montaažikomplekt | Lamp holder for working lights, mounting kit | Носитель фар рабочего освещения, монтажный комплект | Scheinwerferbügel für arbeitsleuchten, Montagesatz

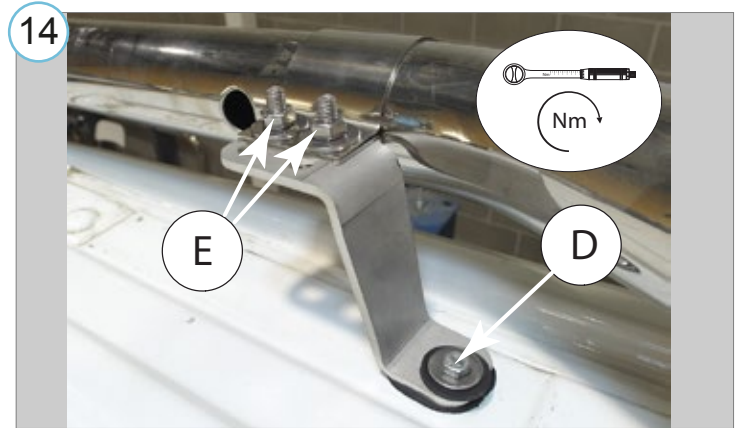
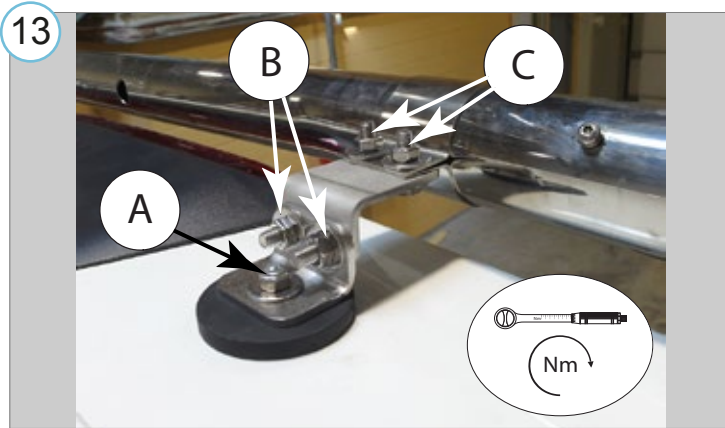
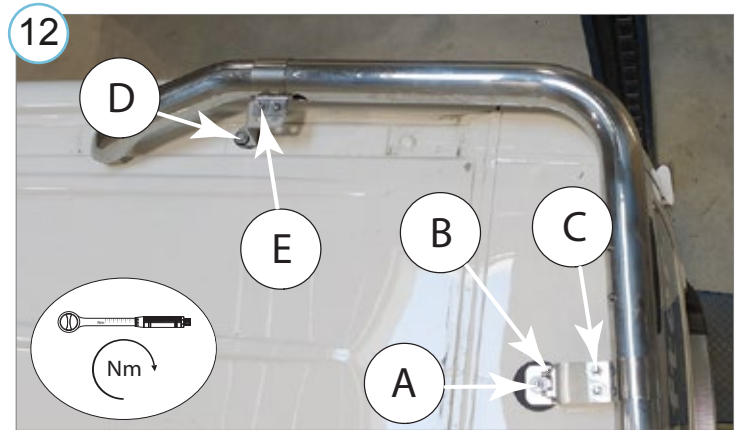
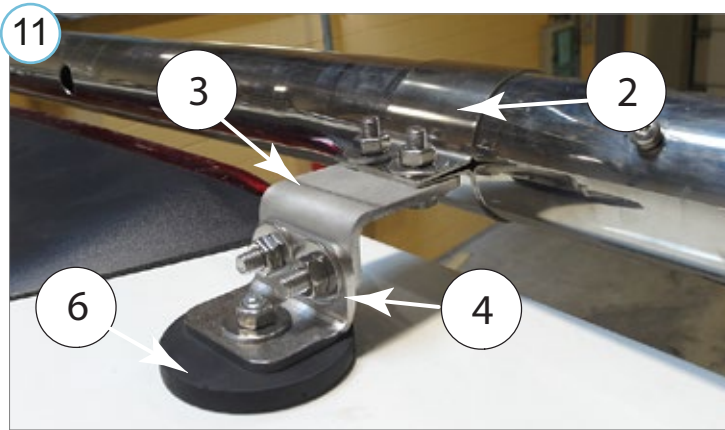
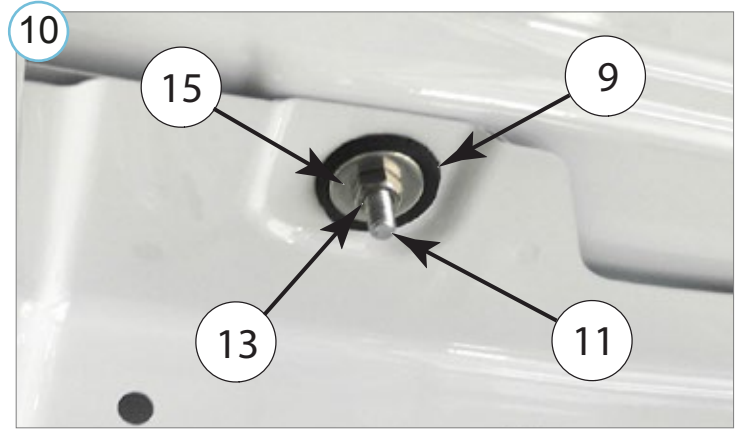
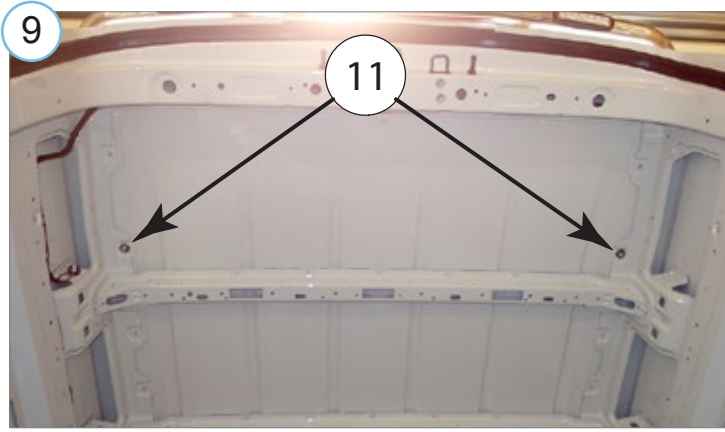

- Kui METEC toode ei vasta Teile ootustele või kui on tegemist toote ebapiisava kvaliteediga, siis pretensioonid esitada lehel [www.metec.ee](http://www.metec.ee)
- If the METEC product does not meet Your expectations or if it is a product of insufficient quality, then you can submit a claim at [www.metec.ee](http://www.metec.ee)
- Если METEC продукт не соответствует Вашим ожиданиям или это продукт недостаточного качества, то претензию предъявить можно на сайте [www.metec.ee](http://www.metec.ee)
- Wenn METEC Produkt nicht Ihren Erwartungen entspricht oder wenn es um Qualitätsmängel geht, dann bitte die Ansprüche auf Seite [www.metec.ee](http://www.metec.ee) einreichen

