



Mitsubishi L200 Double Cab 2015-

Art. 821070, 821071

Põhjakaitse | Skid plate | Защита картера | Motorschutz



- | | |
|---|---|
| 1. Polt / bolt / болт / Bolzen M8x60 | 2 |
| 2. Polt / bolt / болт / Bolzen M8x50 | 2 |
| 3. Polt / bolt / болт / Bolzen M8x30 | 4 |
| 4. Seib / washer / шайба / Scheibe 8,4x24x2 | 8 |
| 5. Vedruseib / spring washer / пружинная шайба / Federnscheibe A8 | 8 |

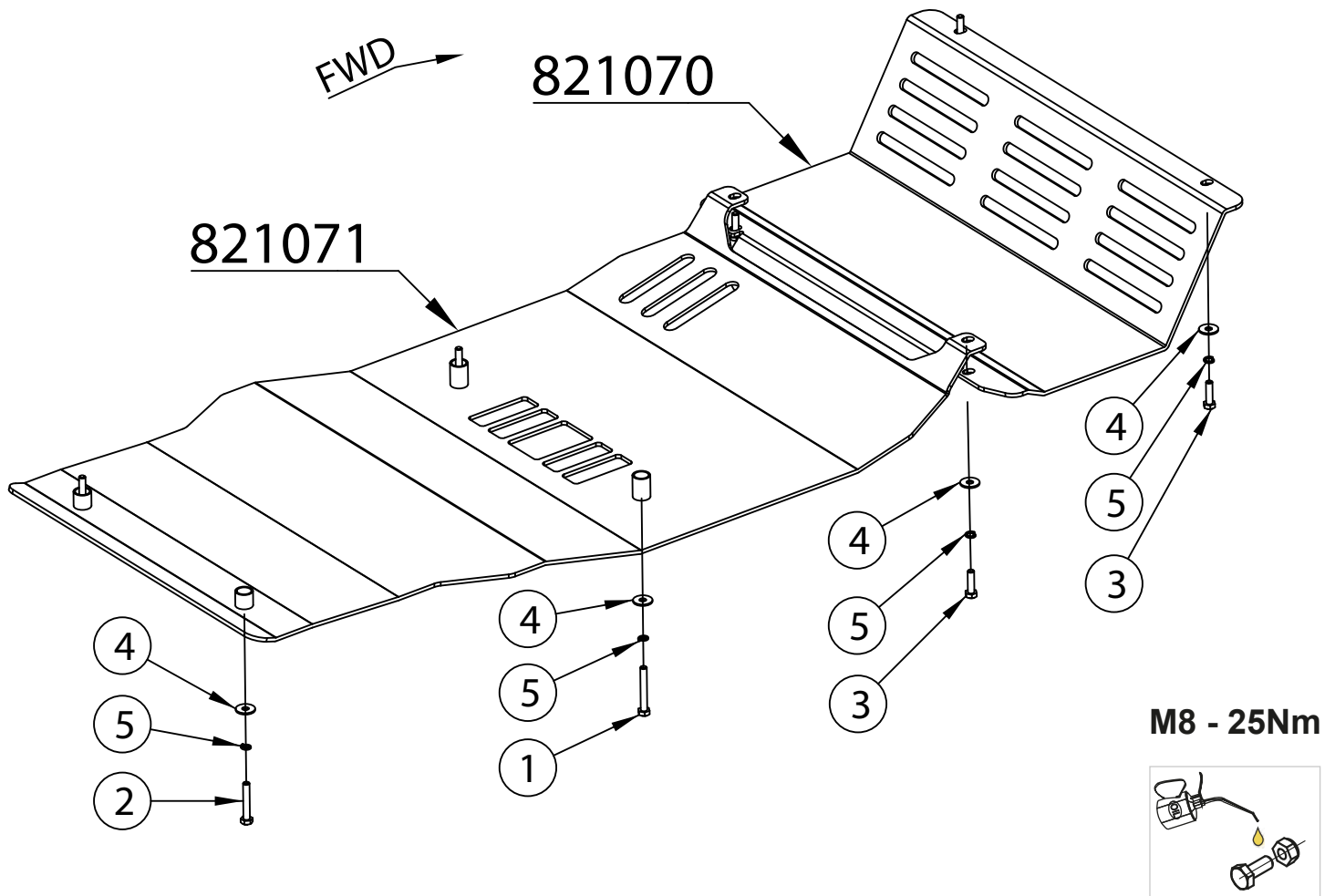

Kaal / Weight / Масса / Gewicht: 12,4kg

Paigaldusaeg / Time of mounting / Время установки / Einbauzeit: 30min

Vajalikud tööriistad / Required Tools / Необходимые инструменты / Benötigte Werkzeuge



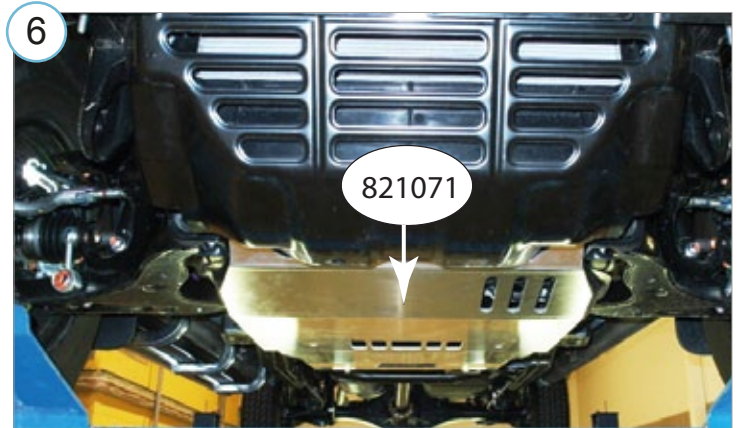
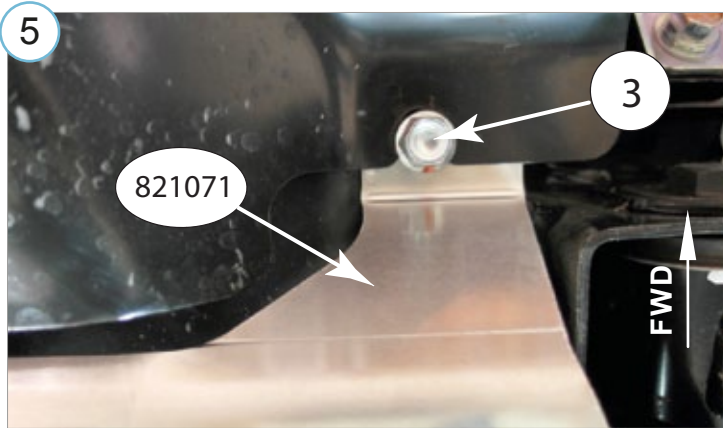
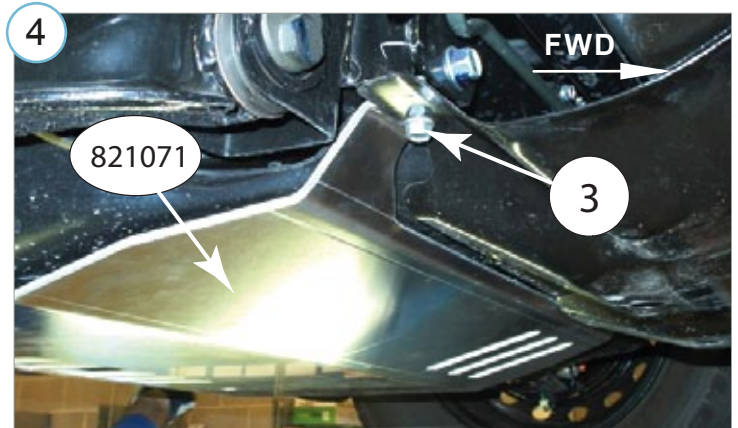
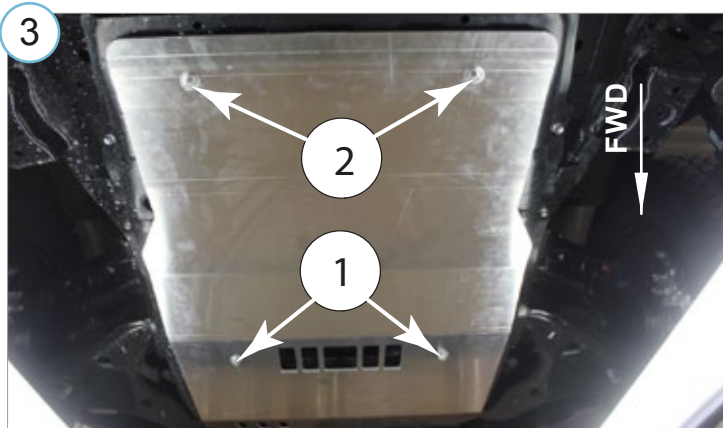
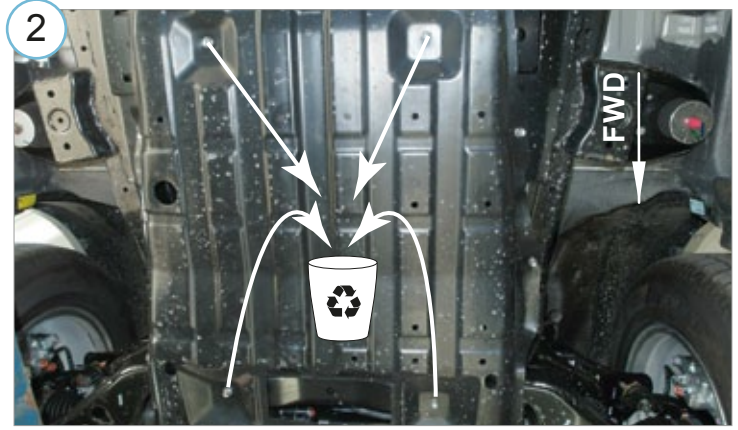
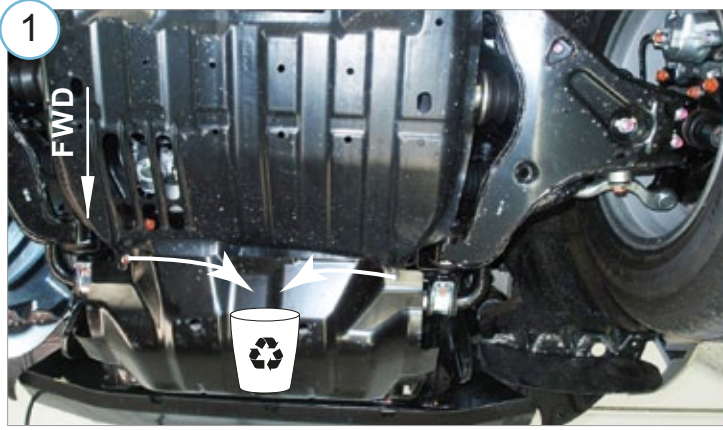

Mitsubishi L200 Double Cab 2015-

Põhjakaitse | Skid plate | Защита картера | Motorschutz

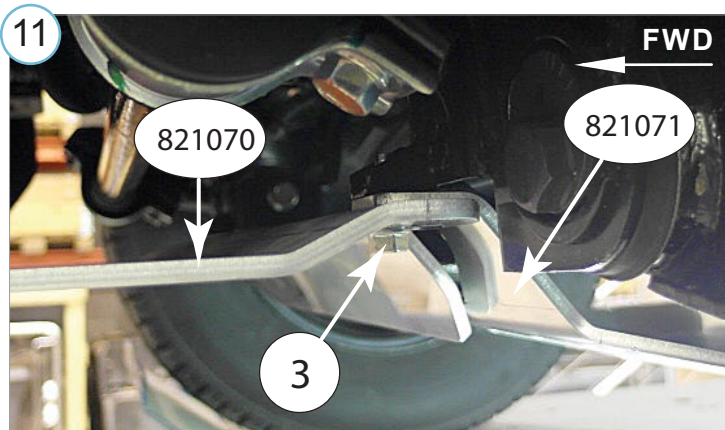
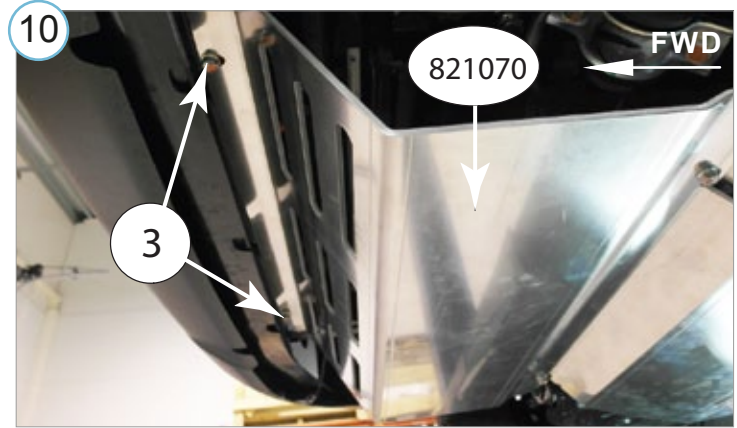
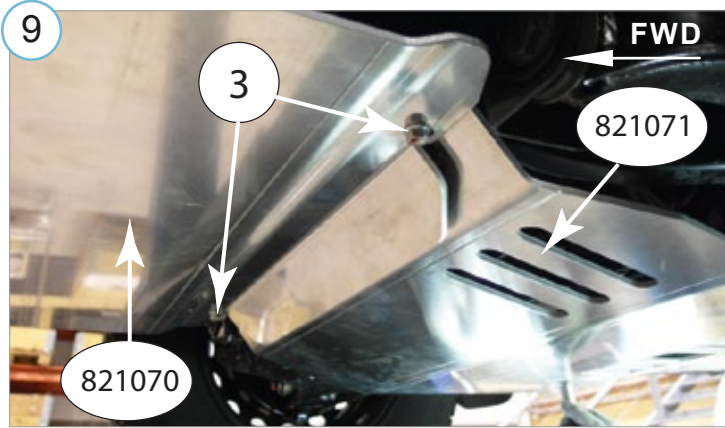

- Kui METEC toode ei vasta Teile ootustele või kui on tegemist toote ebapiisava kvaliteediga, siis pretensioonid esitada lehel www.metec.ee
- If the METEC product does not meet Your expectations or if it is a product of insufficient quality, then you can submit a claim at www.metec.ee
- Если METEC продукт не соответствует Вашим ожиданиям или это продукт недостаточного качества, то претензию предъявить можно на сайте www.metec.ee
- Wenn METEC Produkt nicht Ihren Erwartungen entspricht oder wenn es um Qualitätsmängel geht, dann bitte die Ansprüche auf Seite www.metec.ee einreichen