

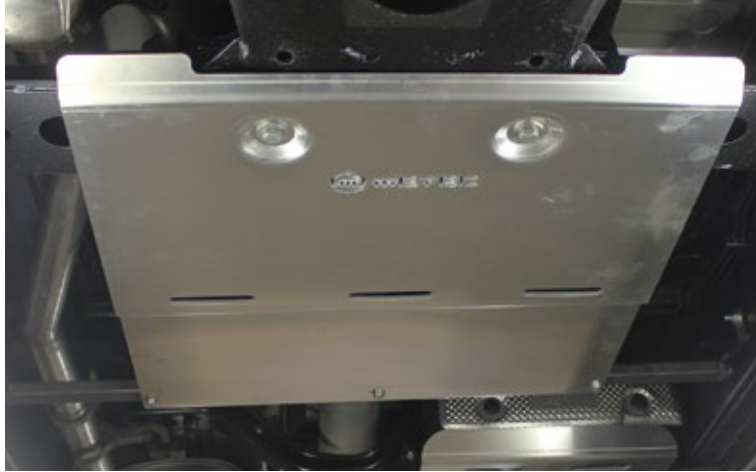

MB X-class 2017- / Nissan Navara 2016- / Renault Alaskan 2017-

Art. 823522

Põhjakaitse vahekastile | Skid plate for transfer case | Защита картера для раздаточной коробки | Motorschutz für das Verteilergetriebe



- | | |
|--|---|
| 1. Põhjakaitse / skid plate / защита картера / Motorschutz | 1 |
| 2. Tala / beam / балка / Strahl | 1 |
| 3. Kronstein / bracket / кронштейн / Konsole | 2 |
| 4. U-polt / U-bolt / U-болт / U-bolzen | 1 |
| 5. Polt / bolt / болт / Bolzen M10x80 | 2 |
| 6. Polt / bolt / болт / Bolzen M8x25 | 7 |
| 7. Mutter / nut / гайка / Mutter M10 | 2 |
| 8. Mutter / nut / гайка / Mutter M6 | 2 |
| 9. Seib / washer / шайба / Scheibe | 2 |
| 10. Seib / washer / шайба / Scheibe 10,5x30x2,5 | 2 |
| 11. Seib / washer / шайба / Scheibe 8,4x16x1,6 | 7 |
| 12. Seib / washer / шайба / Scheibe 6,4x12x1,6 | 2 |
| 13. Vedruseib / spring washer / пружинная шайба / Federnscheibe A8 | 7 |
| 14. Vedruseib / spring washer / пружинная шайба / Federnscheibe A6 | 2 |

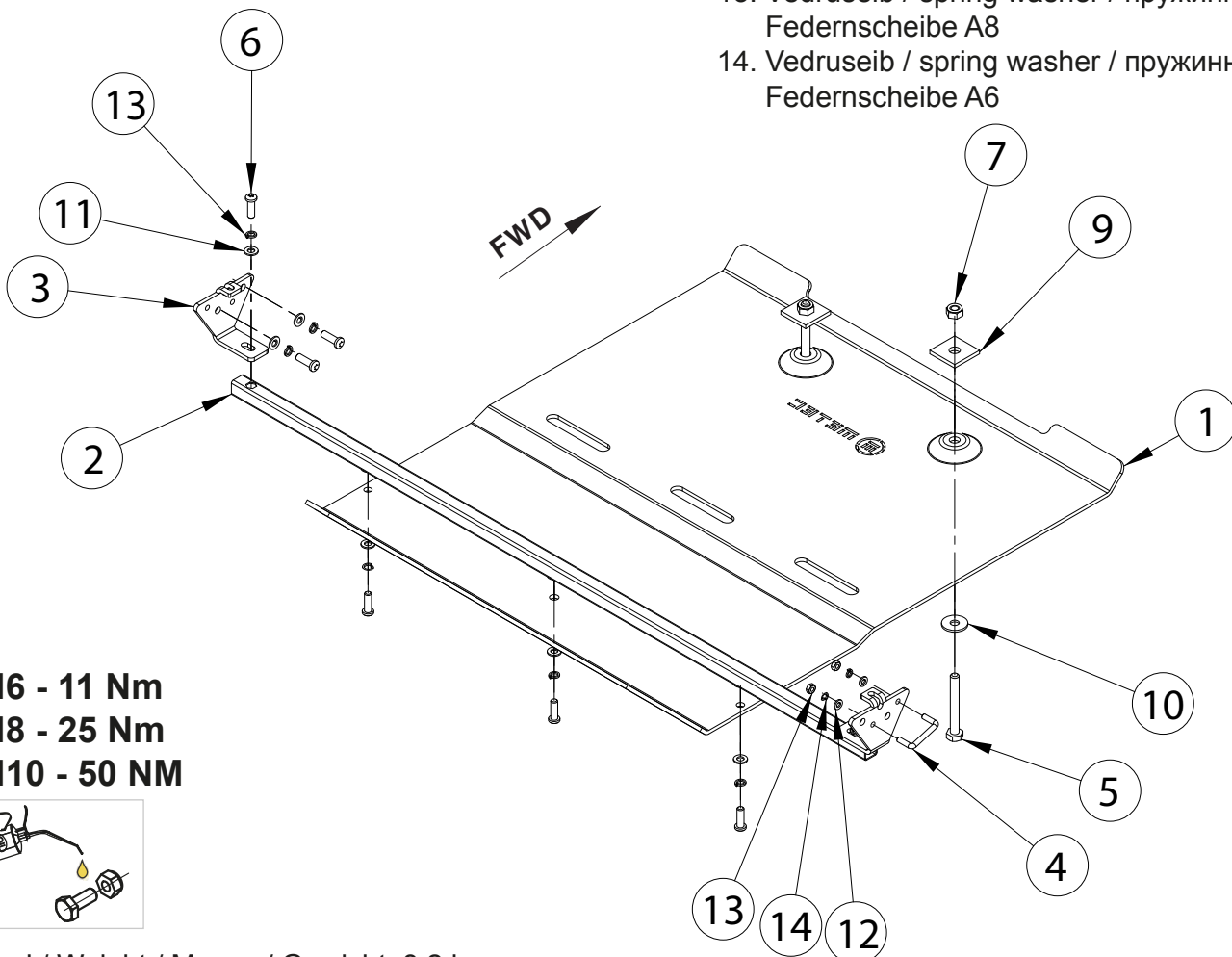

M6 - 11 Nm
M8 - 25 Nm
M10 - 50 NM

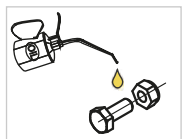

Kaal / Weight / Масса / Gewicht: 8,2 kg

Paigaldusaeg / Time of mounting / Время установки / Einbauzeit: 30 min

Vajalikud tööriistad / Required Tools / Необходимые инструменты / Benötigte Werkzeuge



MB X-class 2017- / Nissan Navara 2016- / Renault Alaskan 2017-

Põhjakaitse vahekastile | Skid plate for transfer case | Защита картера для раздаточной коробки | Motorschutz für das Verteilergetriebe

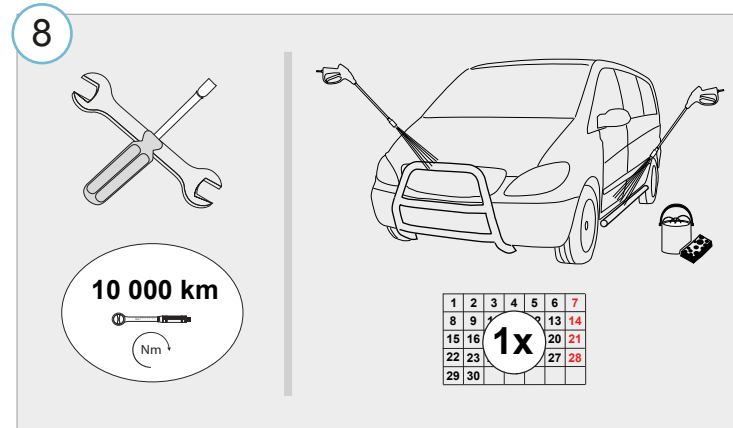
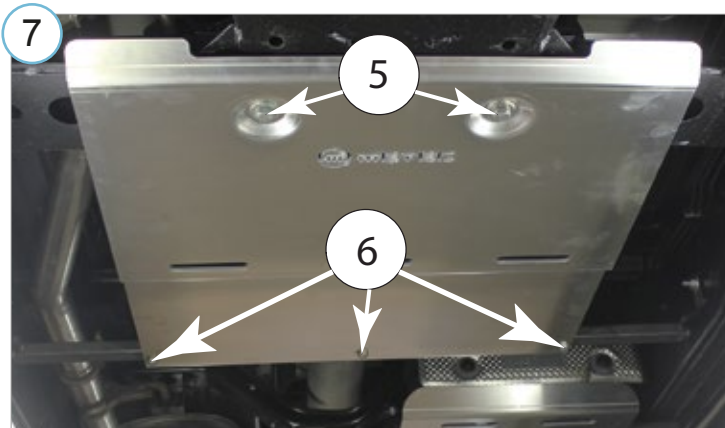
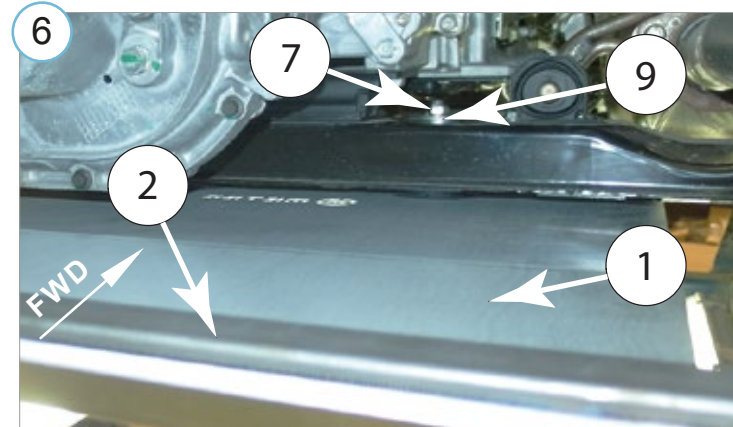
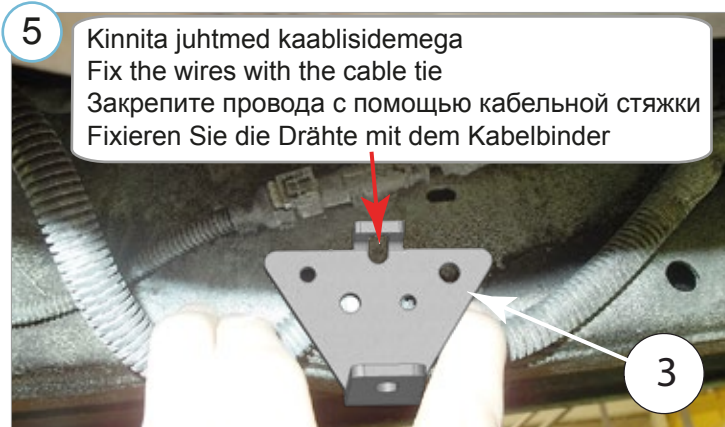
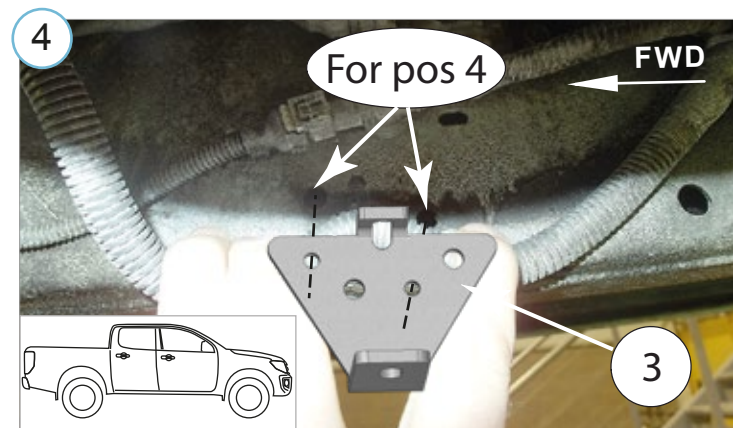
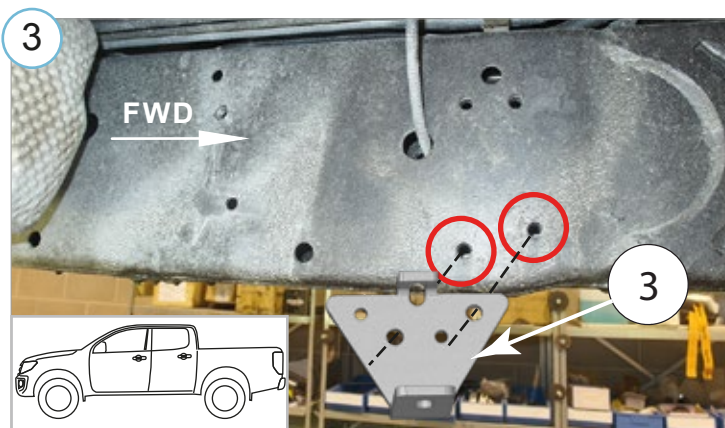
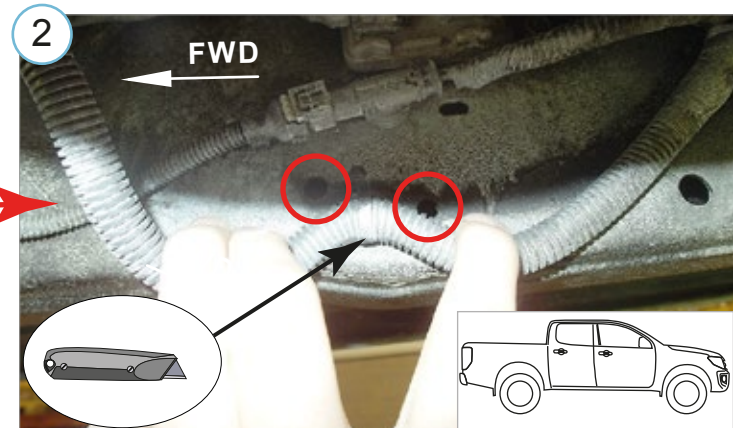
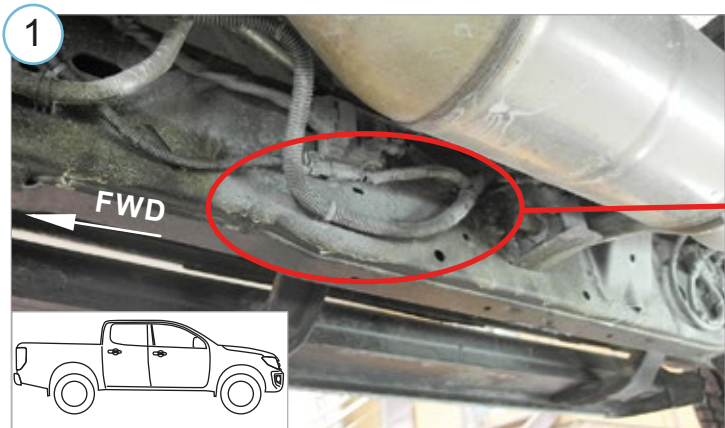

• Kui METEC toode ei vasta Teie ootustele või kui on tegemist toote ebapiisava kvaliteediga, siis pretensioonid esitada lehel www.metec.ee
 • If the METEC product does not meet Your expectations or if it is a product of insufficient quality, then you can submit a claim at www.metec.ee
 • Если METEC продукт не соответствует Вашим ожиданиям или это продукт недостаточного качества, то претензию предъявить можно на сайте www.metec.ee
 • Wenn METEC Produkt nicht Ihren Erwartungen entspricht oder wenn es um Qualitätsmängel geht, dann bitte die Ansprüche auf Seite www.metec.ee einreichen