



Montaažiskeem / Mounting Instructions / Монтажная схема

MB Actros 2011-

Art. 856580
Art. 856581

Esitõke Ø 60 | Front protection pipe Ø 60 | Передняя защитная труба Ø 60



1. Esitõke / protection pipe / защитная труба	1
2. Kronstein / bracket / кронштейн	1
3. Kronstein / bracket / кронштейн	1
4. Kronstein / bracket / кронштейн	1
5. Kronstein / bracket / кронштейн	1
6. Põlt / bolt / болт M8x30 mm	4
7. Põlt / bolt / болт M14x30 mm	2
8. Mutter / nut / гайка M8 DIN 985	4
9. Seib / washer / шайба 8,4x24x2 mm	8
10. Seib / washer / шайба 15x28x2,5 mm	2
11. Vedruseib / spring washer / пружинная шайба A14	2

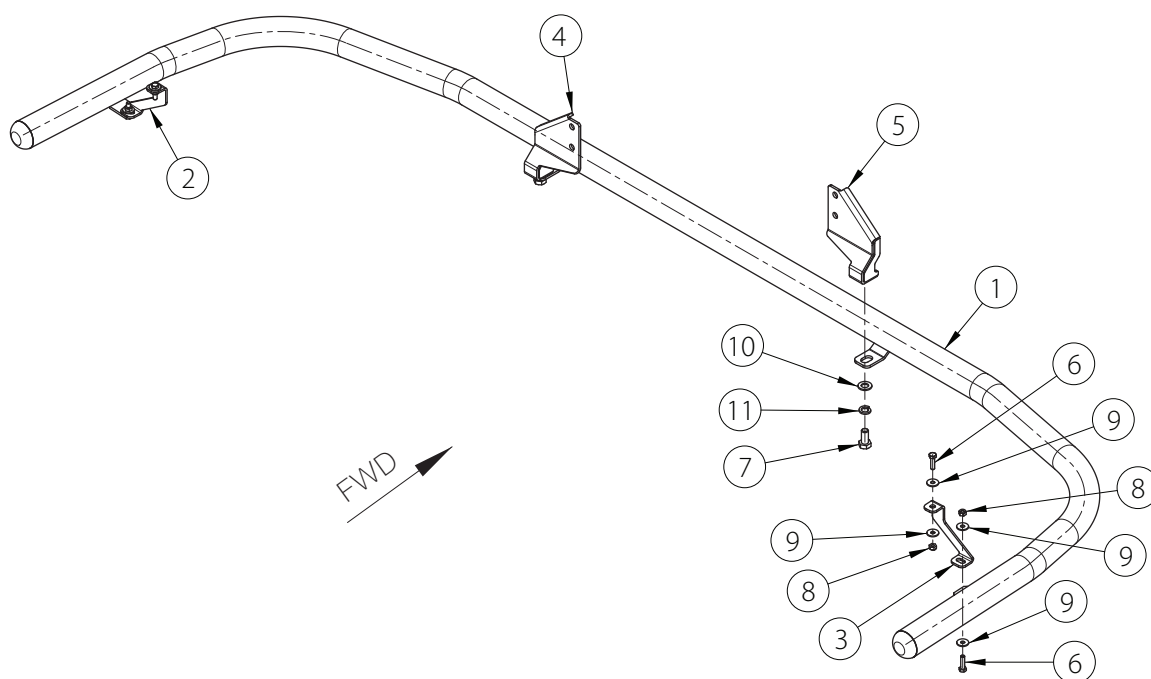

Vajalikud tööriistad / Required Tools / Необходимые инструменты

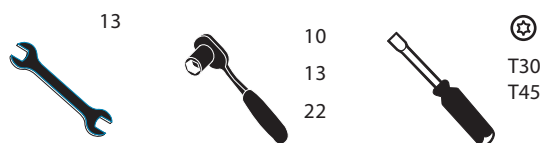



Pilt 1 / Pic. 1 / Рис. 1



Pilt 2 / Pic. 2 / Рис. 2



Pilt 3 / Pic. 3 / Рис. 3

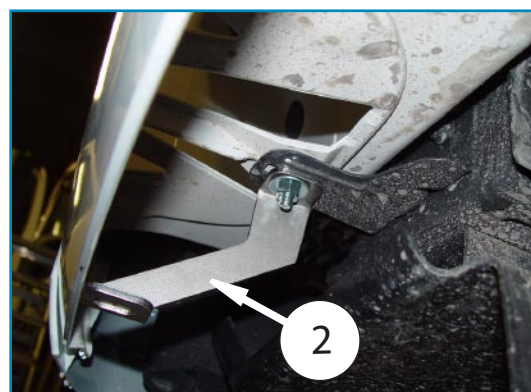

Pilt / Pic. 4 / Рис. 4



Pilt 5 / Pic. 5 / Рис. 5



Pilt 6 / Pic. 6 / Рис. 6

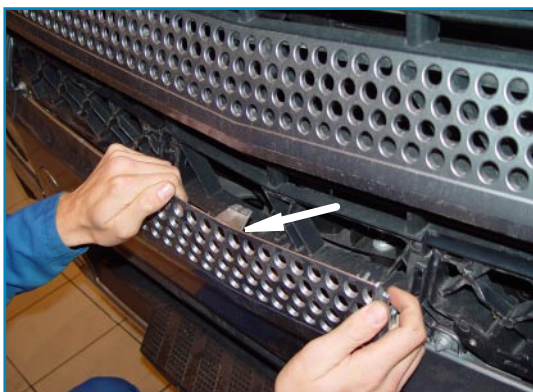

Pilt 7 / Pic. 7 / Рис. 7

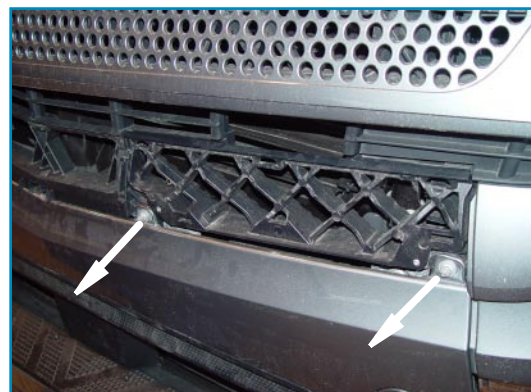

Pilt 8 / Pic. 8 / Рис. 8



Pilt 9 / Pic. 9 / Рис. 9



Pilt 10 / Pic. 10 / Рис. 10

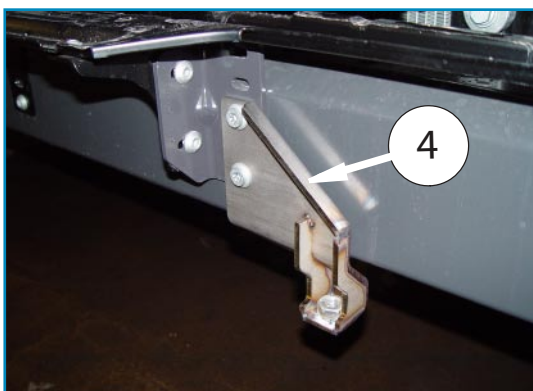

Pilt 11 / Pic. 11 / Рис. 11

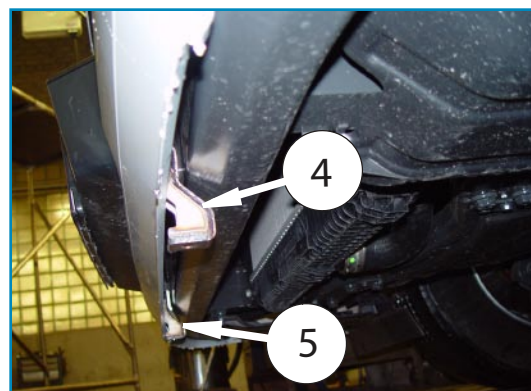

Pilt 12 / Pic. 12 / Рис. 12

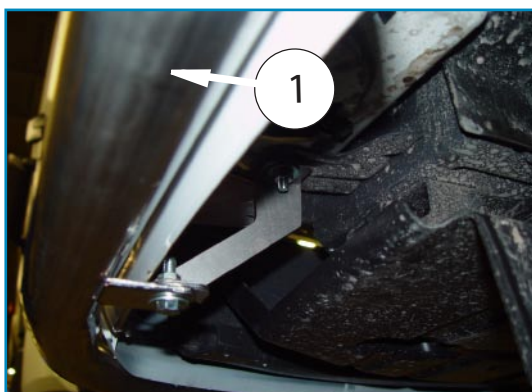

Pilt 13 / Pic. 13 / Рис. 13

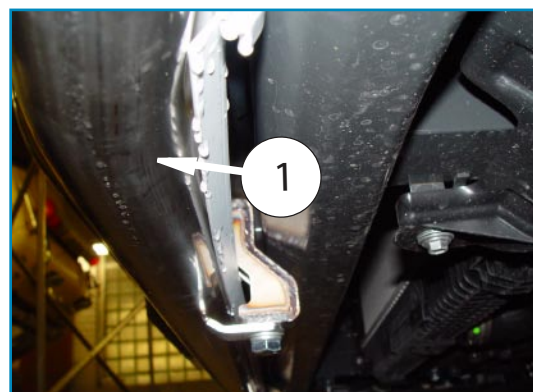

Pilt 14 / Pic. 14 / Рис. 14

Toote andmed / Data of the product / Данные о товаре

- Mõõdud / Measures / Размеры: 70x800x2570 mm.
- Kaal / Weight / Масса: 11,4 kg.
- Paigaldusaeg / Time of mounting / Время установки: 60 min.
- Tähtsad markeeringud / Important labels / Важные этикетки:



1. Komplekteerija number. / The number of the assembler / Номер комплектовщика
2. Tooteinfo pakendil / Product information on the package / Информация на упаковке
3. Tooteinfo tootel / Product information on the proct / Информация на товаре
4. Kvaliteedi kontrolli tähis / Quality control number / Знак контроля качества