



DAF XF, XG, XG+ 2021-

Art. 850330

Kaitseraud MEGA | Gattleguard MEGA | Передняя дуга MEGA | LKW Bullfänger MEGA



- | | |
|---|----|
| 1. Kaitseraud / Truck cattleguard / Передняя дуга / LKW Bullfänger | 1 |
| 2. Kronstein / bracket / кронштейн / Konsole | 1 |
| 3. Kronstein / bracket / кронштейн / Konsole | 1 |
| 4. Kronstein / bracket / кронштейн / Konsole | 1 |
| 5. Kronstein / bracket / кронштейн / Konsole | 1 |
| 6. Vinkel / angeled plate / угольник / winkel | 2 |
| 7. Kronstein / bracket / кронштейн / Konsole | 2 |
| 8. Toru / pipe / труба / Rohr 40x20 | 1 |
| 9. Numbrimärgi alus License plate holder Рамка номерного знака Kennzeichenverstärken | 2 |
| 10. Lülük / plate nut / пластина с гайкой / Platte mit mutter | 2 |
| 11. Laterna kinnituskronstein / lamp fixing bracket / крепежный кронштейн лампы / Lampenbefestigungsklammer | 4 |
| 12. Plaat / plate / пластина / Platte | 4 |
| 13. Polt / bolt / болт / Bolzen M6x16 | 2 |
| 14. Polt / bolt / болт / Bolzen M8x20 | 10 |
| 15. Polt / bolt / болт / Bolzen M8x25 DIN933-A2 | 6 |
| 16. Polt / bolt / болт / Bolzen M8x25 DIN7991-A2 | 4 |
| 17. Polt / bolt / болт / Bolzen M8x30 | 2 |
| 18. Polt / bolt / болт / Bolzen M10x30 | 10 |
| 19. Mutter / nut / гайка / Mutter M6 | 2 |
| 20. Mutter / nut / гайка / Mutter M8 | 2 |
| 21. Mutter / nut / гайка / Mutter M10 | 10 |
| 22. Seib / flat washer / шайба / Scheibe 6,4x18x1,6 | 4 |
| 23. Seib / flat washer / шайба / Scheibe 8,4x16x1,6 | 24 |
| 24. Seib / flat washer / шайба / Scheibe 10,5x20x2 | 8 |
| 25. Seib / flat washer / шайба / Scheibe 10,5x30x2,5 | 12 |
| 26. Vedruseib / spring washer / пружинная шайба / Federnscheibe A8 | 20 |
| 27. Pinguti võti / tensioner key / ключ натяжителя / Spannschlüssel | 1 |

Elektriühendused teostada kvalifitseeritud autoelektriku poolt

Installation of the lights can be carried out by qualified electrician only

Монтаж огней может быть выполнено только квалифицированным электриком

Die Installation der Lichter können durchgeführt werden durch Elektrofachkraft

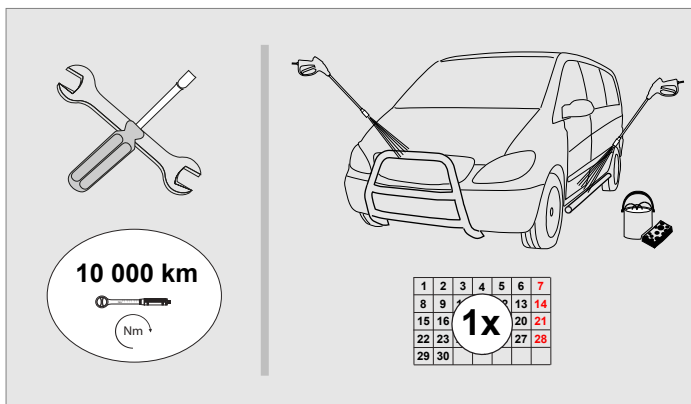

M6 - 11 Nm
M8 - 25 Nm
M10 - 50 Nm

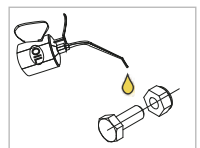

Kaal / Weight / Масса / Gewicht: 84 kg

Paigaldusaeg ilma elektritöödeta / Time of mounting w/o wiring works / Время установки без электромонт. работ / Einbauzeit ohne elektrische arbeit: 60 min

Vajalikud tööriistad / Required Tools / Необходимые инструменты / Benötigte Werkzeuge

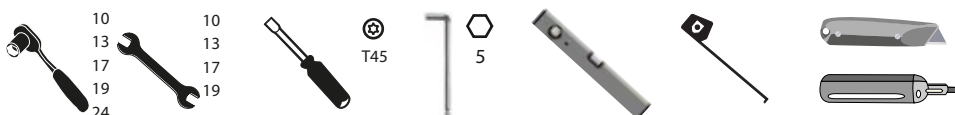

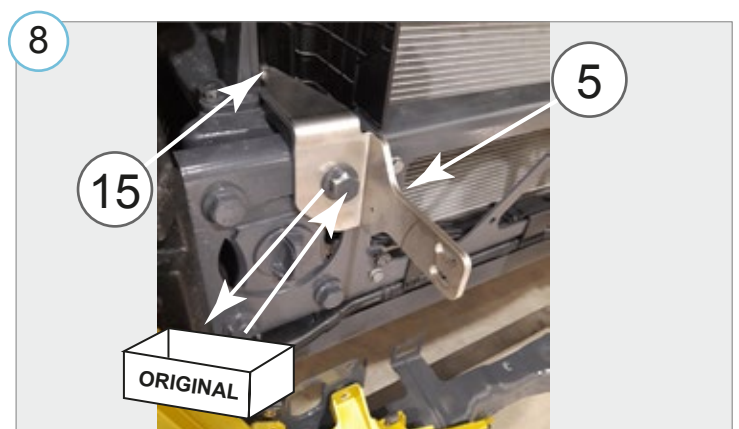
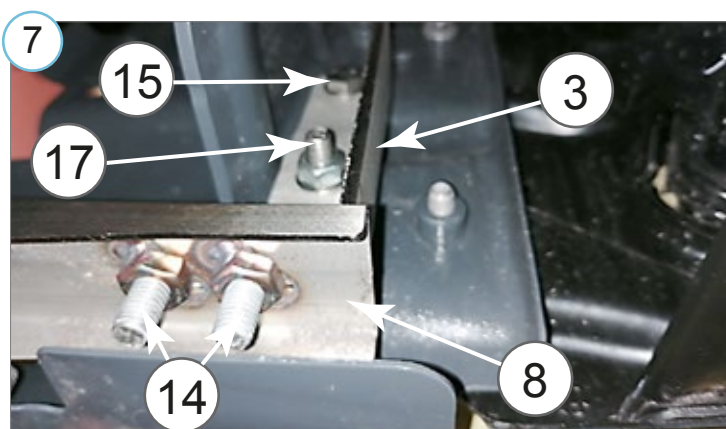
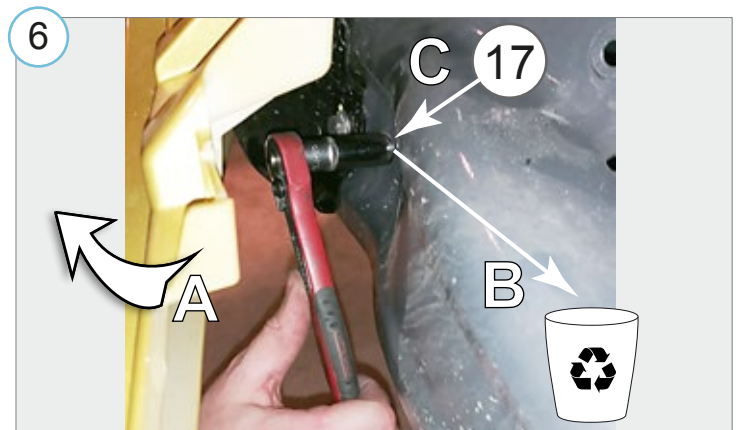
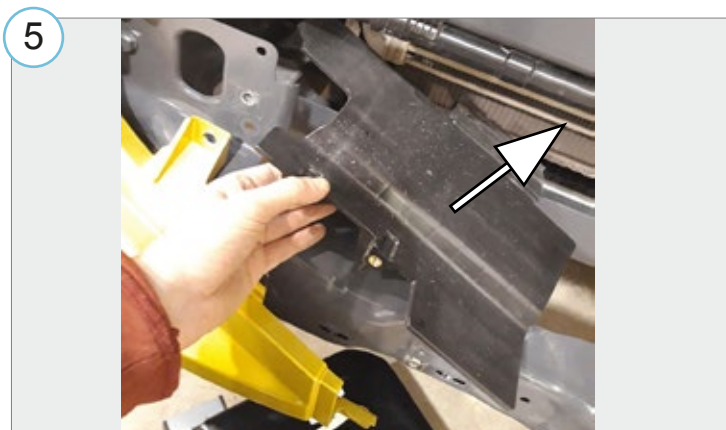
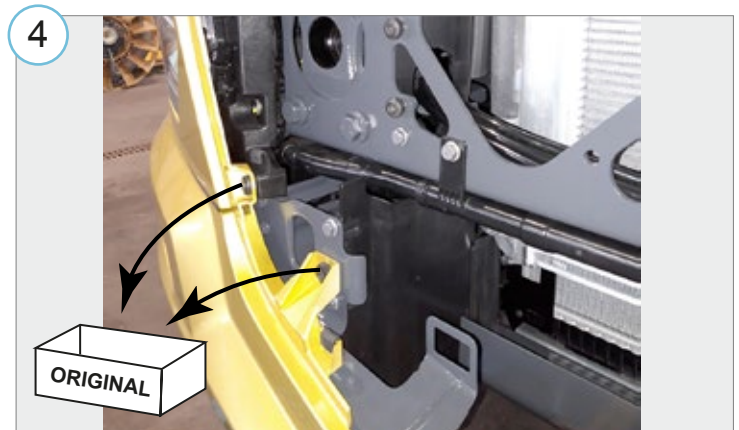
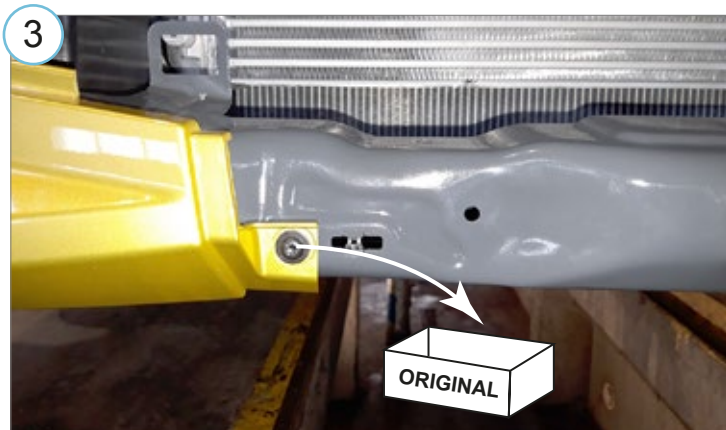
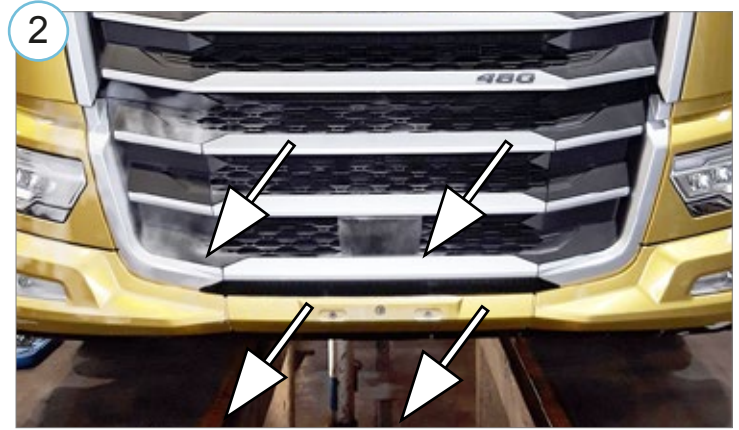
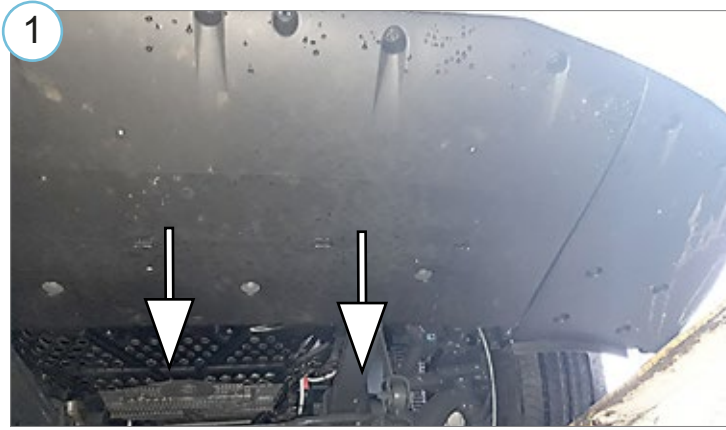

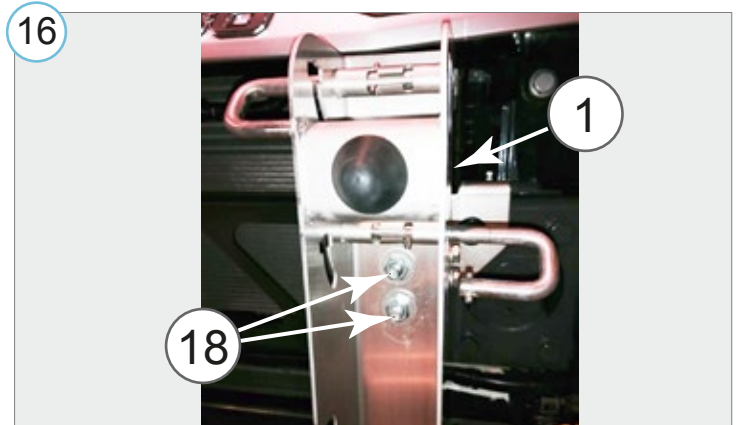
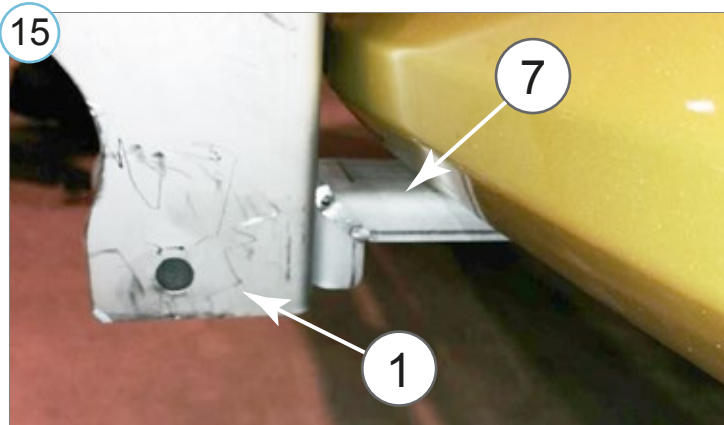
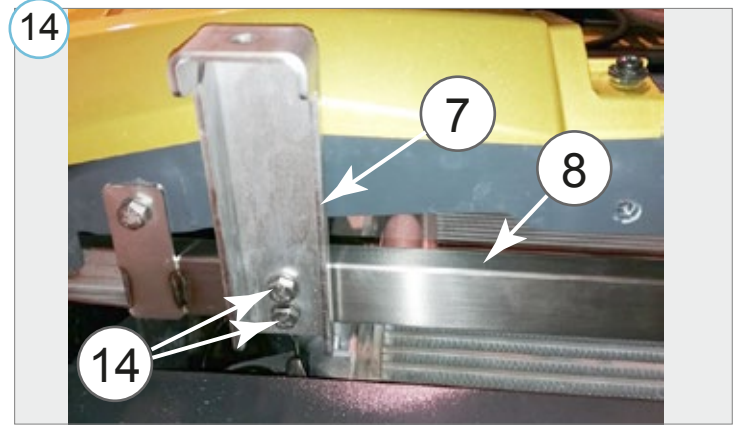
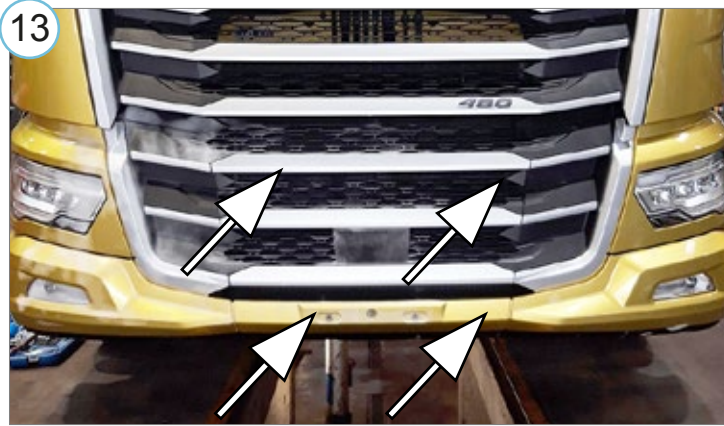
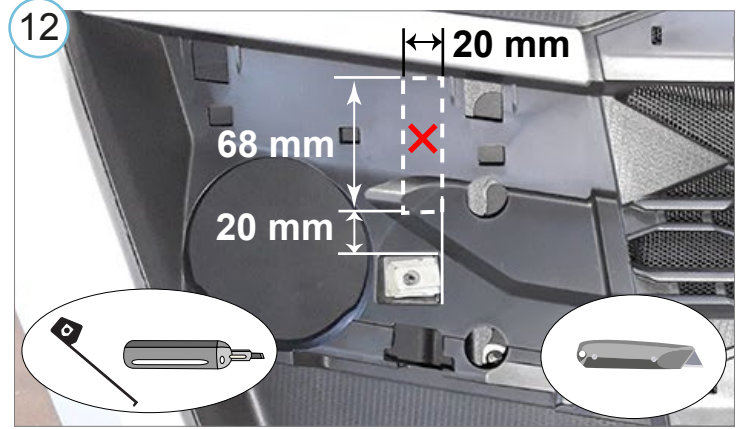
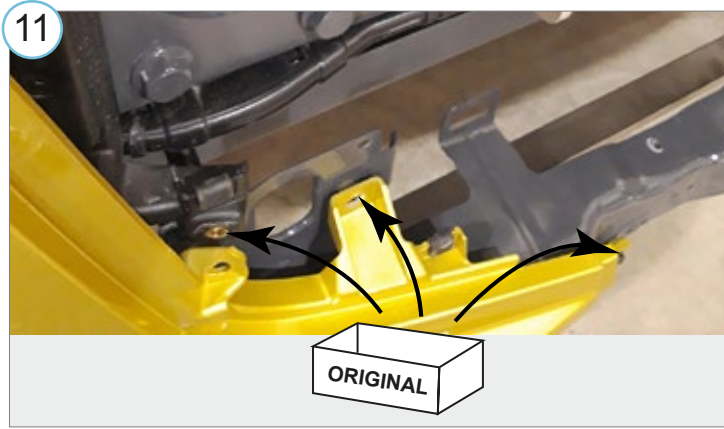
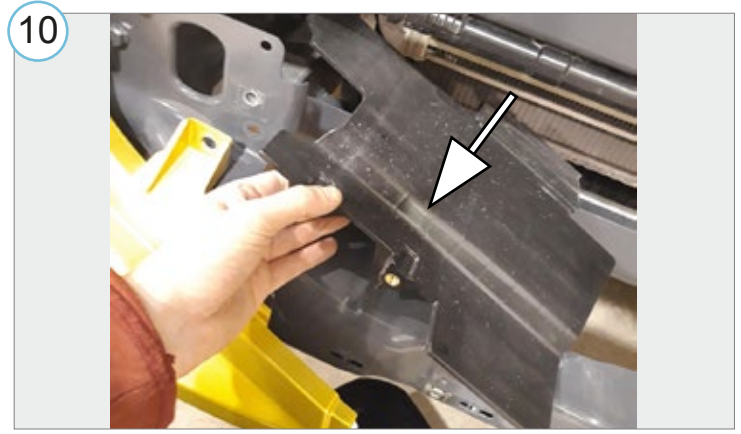
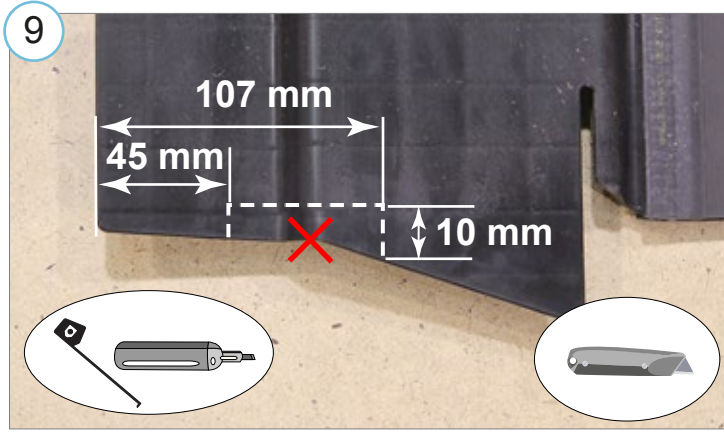

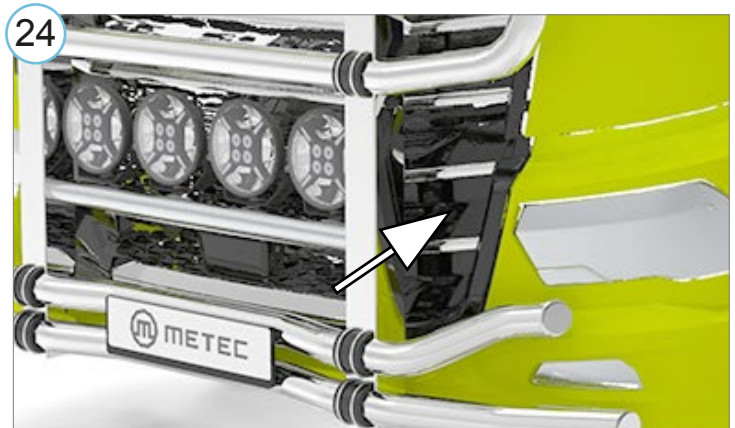
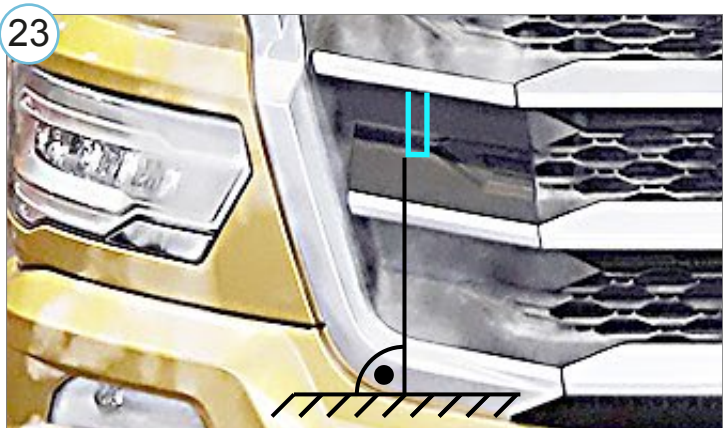
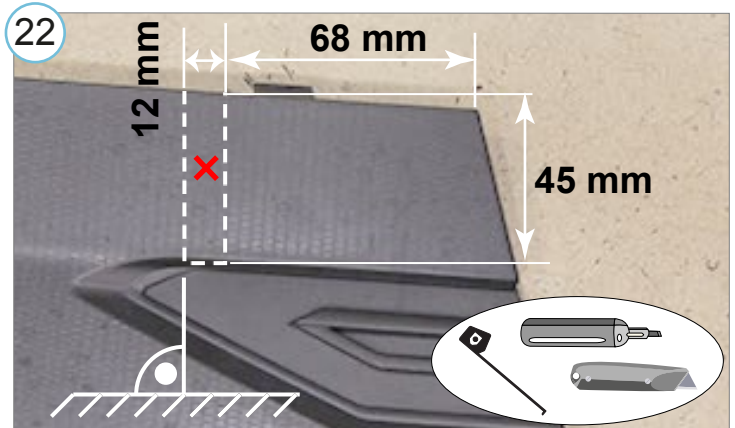
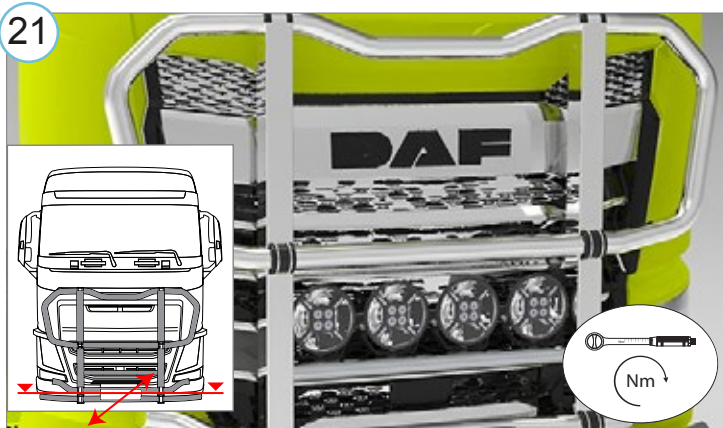
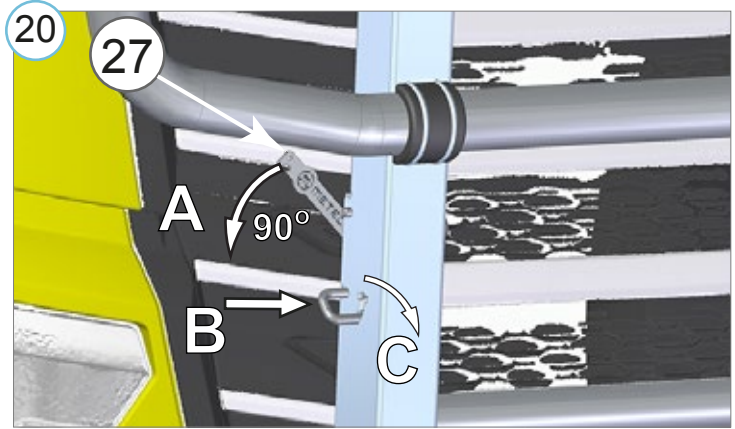
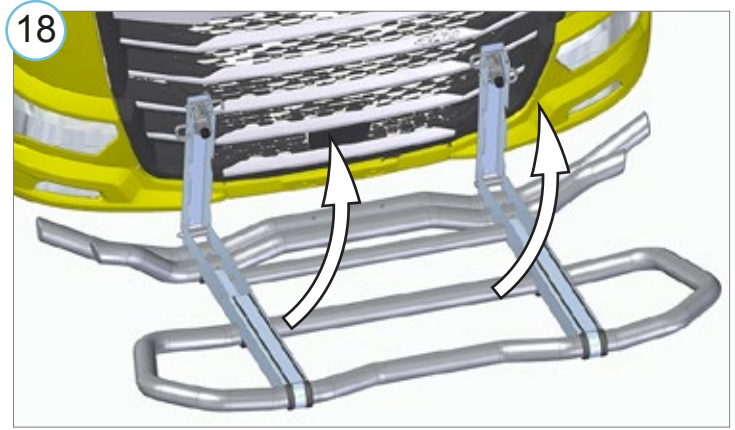
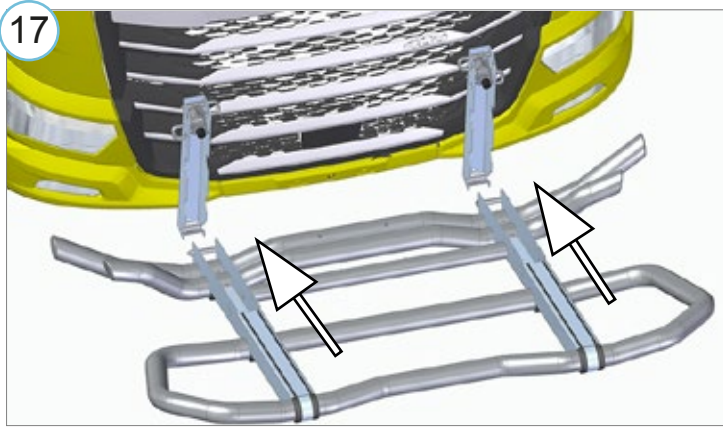

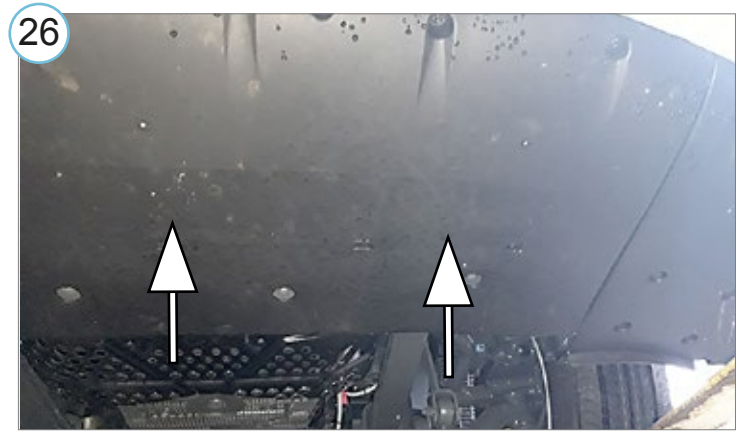
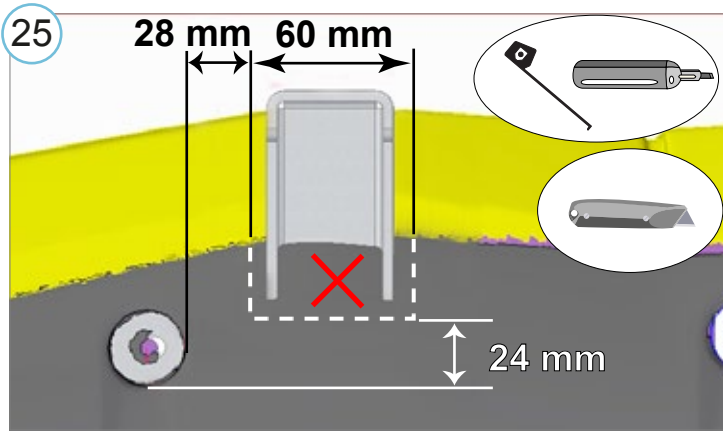

Kaitseraava eemaldamine / Removing the gattleguard Снятие дуги / Entfernen der LKW Bullfänger

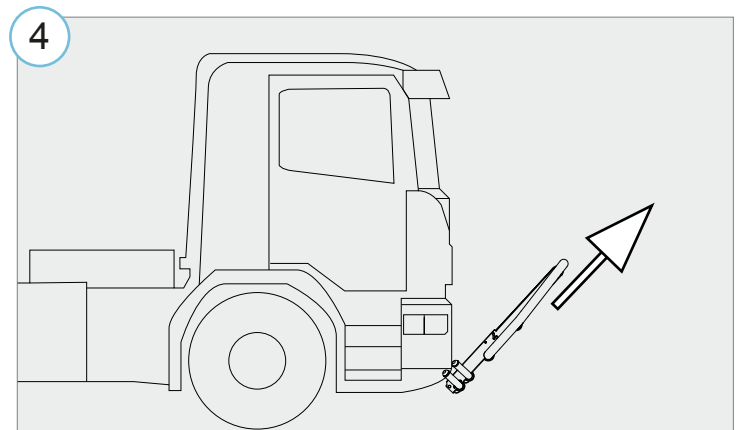
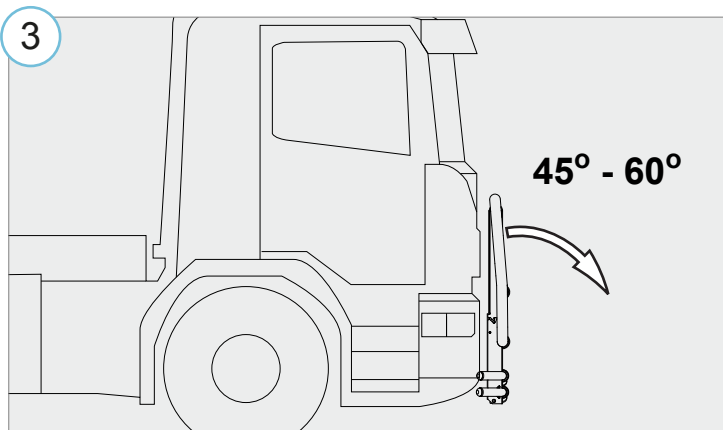
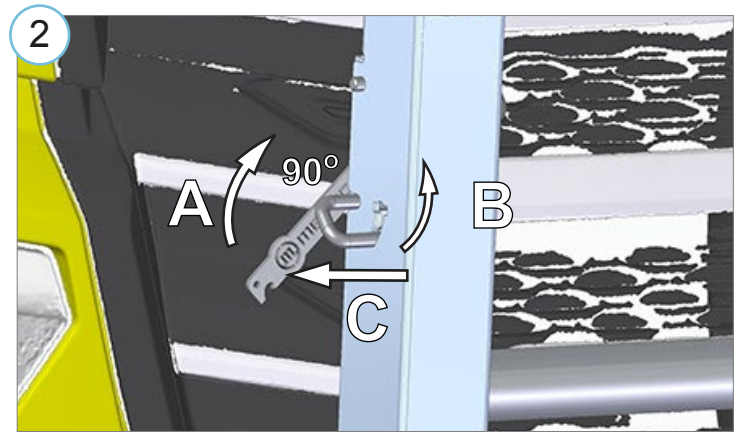
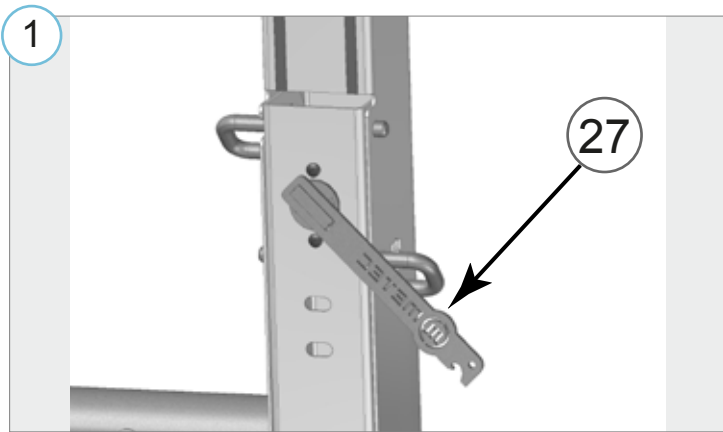

Lisa / extra / приложение / Extra

