

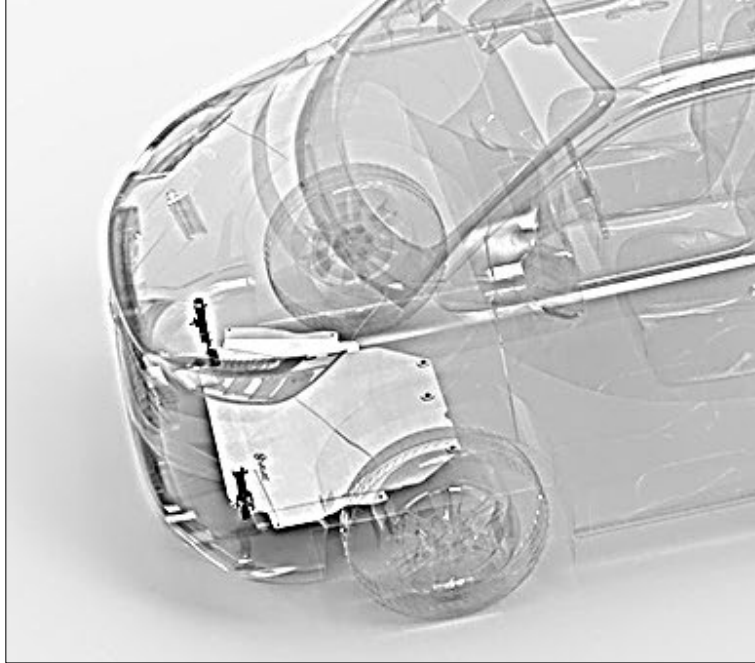

# Ford Transit/Tourneo Custom 23-

Art. 807456

Põhjakaitse | Skid plate | Motorschutz



1. Põhjakaitse / skid plate / Motorschutz	1
2. Kronstein / bracket / Konsole	1
3. Kronstein / bracket / Konsole	1
4. T-polt / T-bolt / T-bolzen M10x40	1
5. T-polt / T-bolt / T-bolzen M10x40	1
6. Kronstein / bracket / Konsole	1
7. Kronstein / bracket / Konsole	1
8. Kronstein / bracket / Konsole	1
9. Kronstein / bracket / Konsole	1
10. Puks / bushing / Buchse	2
11. Polt / bolt / Bolzen M6x30 DIN933-galZn	3
12. Polt / bolt / Bolzen M8x30 DIN933-galZn	8
13. Polt / bolt / Bolzen M10x20 DIN933-galZn	2
14. Polt / bolt / Bolzen M10x50 DIN933-galZn	2
15. Mutter / nut / Mutter M10 DIN934-galZn	4
16. Mutter / nut / Mutter M10x30 DIN6334-galZn	2
17. Seib / flat washer / Scheibe 6,4x18x1,6	3
18. Seib / flat washer / Scheibe 8,4x16x1,6	4
19. Seib / flat washer / Scheibe 8,4x24x2	4
20. Seib / flat washer / Scheibe 10,5x20x2	4
21. Vedruseib / spring washer / Federnscheibe A6	3
22. Vedruseib / spring washer / Federnscheibe A8	8
23. Vedruseib / spring washer / Federnscheibe A10	6

### Zn

M6	-	9,8 Nm
M8	-	24 Nm
M10	-	47 Nm

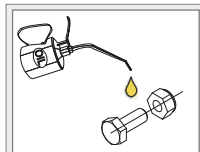

**Külmkeevituse vältimiseks kasutada külmkeevitusvastast määret või mootoriõli.**

**To prevent cold welding, use cold weld grease or engine oil.**

**Verwenden Sie geeignetes Fett oder Motoröl, um die Kaltverschweißung zu verhindern.**

Kaal / Weight / Gewicht: 12,8 kg

Paigaldusaeg ilma elektritöödeta / Time of mounting w/o wiring works / Einbauzeit ohne elektrische arbeit: 20 min

## Vajalikud tööriistad / Required Tools / Benötigte Werkzeuge



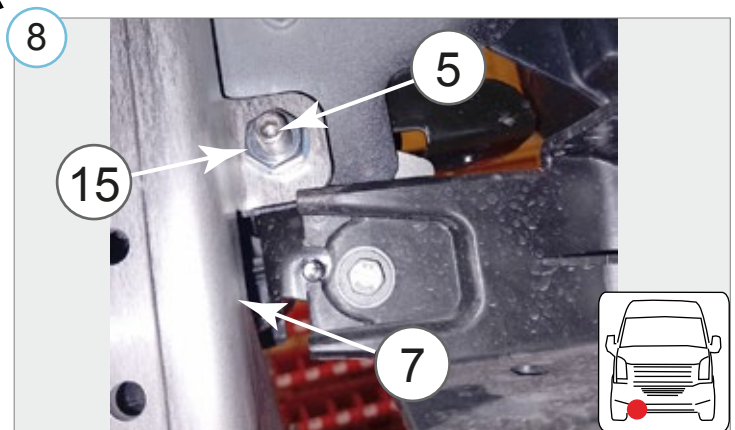
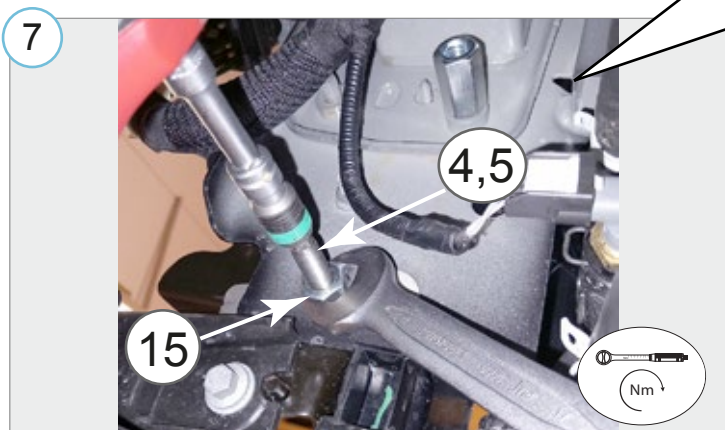
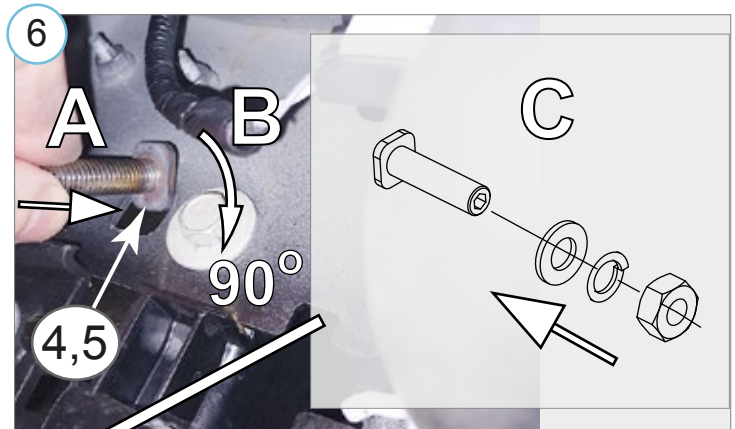
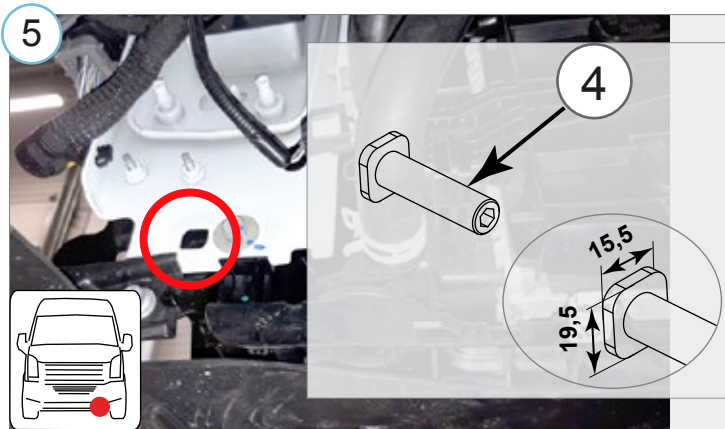
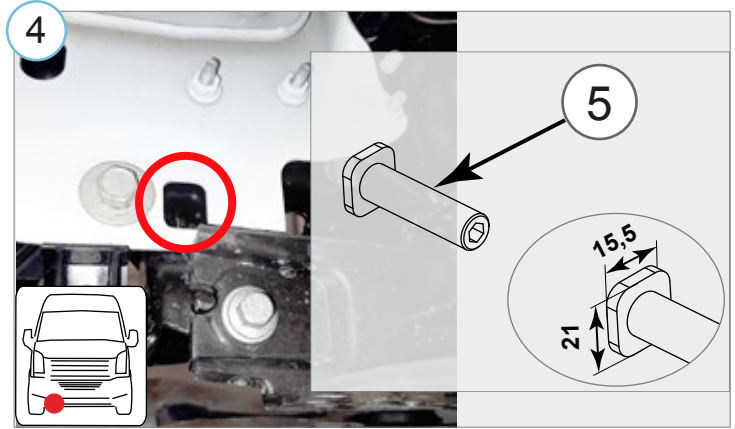
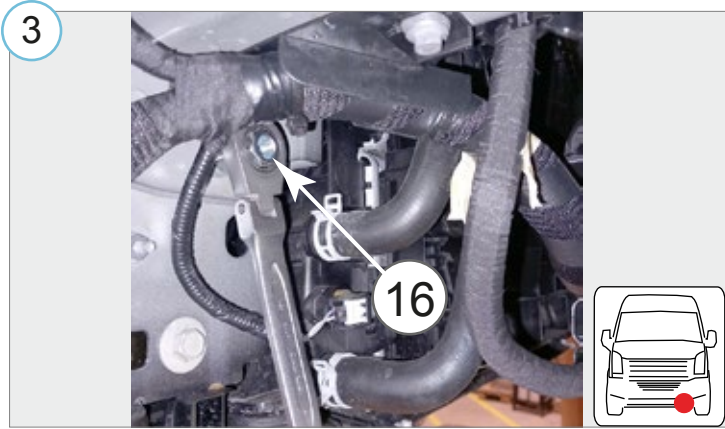
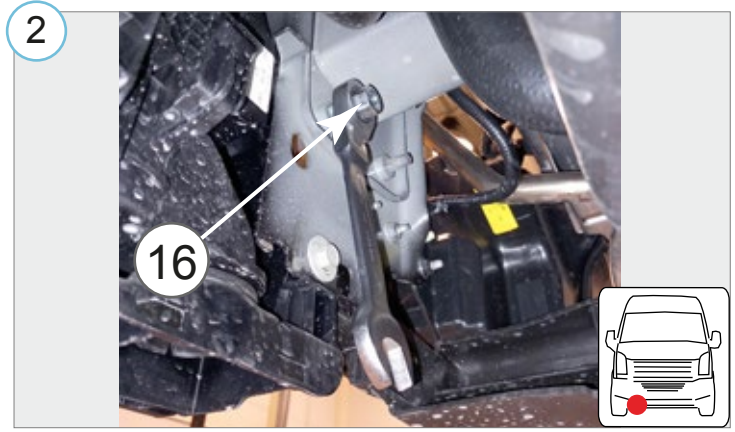



**Ford Transit/Tourneo Custom 23-**  
**Põhjakaitse | Skid plate | Motorschutz**

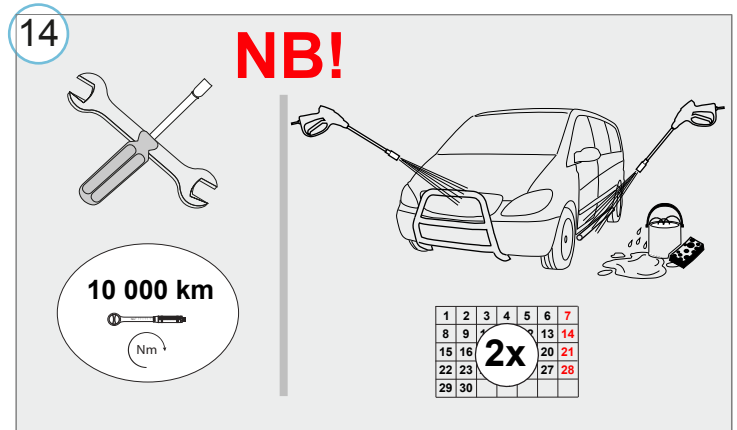
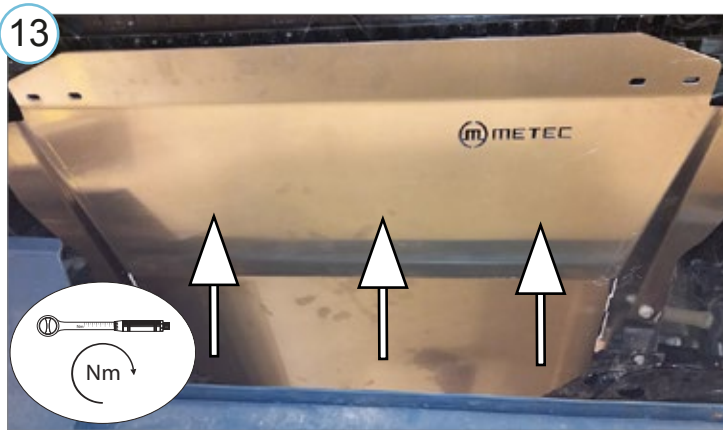
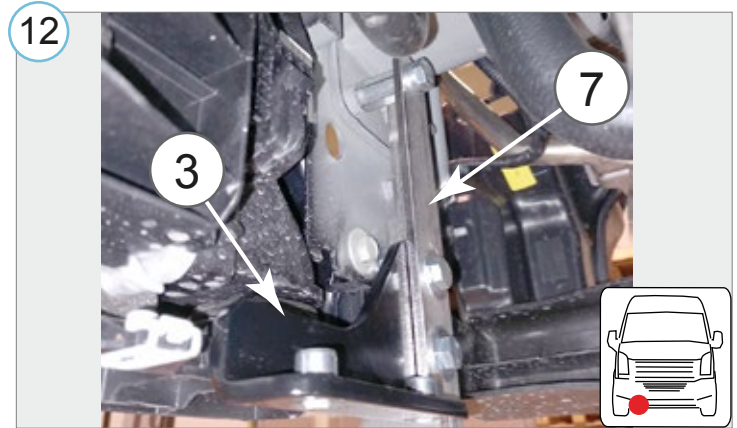
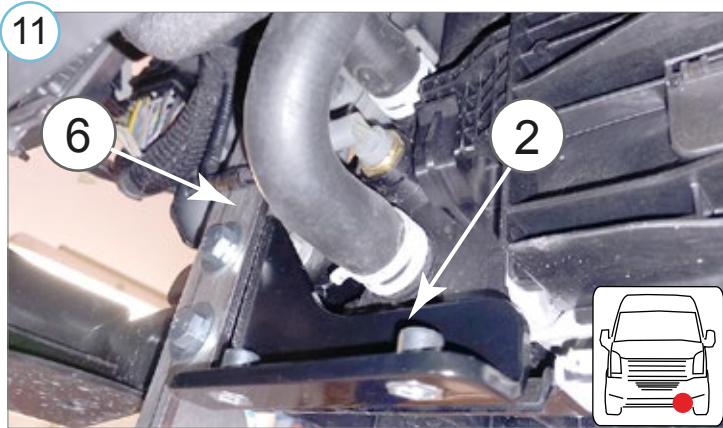
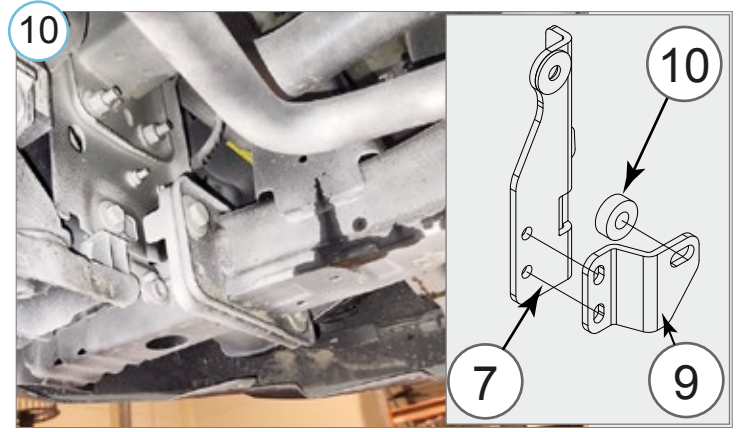
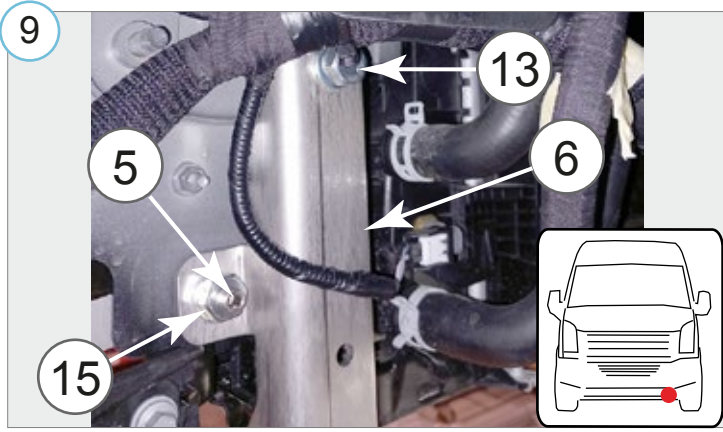

- Kui METEC toode ei vasta Teie ootustele või kui on tegemist toote ebapiisava kvaliteediga, siis pretensioonid esitada lehel [www.metec.ee](http://www.metec.ee)
- If the METEC product does not meet Your expectations or if it is a product of insufficient quality, then you can submit a claim at [www.metec.ee](http://www.metec.ee)
- Wenn METEC Produkt nicht Ihren Erwartungen entspricht oder wenn es um Qualitätsmängel geht, dann bitte die Ansprüche auf Seite [www.metec.ee](http://www.metec.ee) einreiche

Lisa / extra / Extra

