



MAN TGX HIGH 2020-

Art. 854580, 854581 (GX)

Laternakandur V-MAX | Lamp holder VISOR-MAX | Носител фар V-MAX | Scheinwerferbüge V-MAX



- | | |
|---|----|
| 1. Look / arc / дуга / Bogen | 1 |
| 2. Polditav kronstein / bolt bracket / кронштейн / Bolzenhalterung | 2 |
| 3. Kronstein / bracket / кронштейн / Konsole | 1 |
| 4. Kronstein / bracket / кронштейн / Konsole | 1 |
| 5. Kronstein / bracket / кронштейн / Konsole | 1 |
| 6. Kronstein / bracket / кронштейн / Konsole | 1 |
| 7. Tihend / gasket / прокладка / Dichtung | 4 |
| 8. Kruvi / screw / винт / Schraube 6x40 | 8 |
| 9. Polt / bolt / болт / Bolzen M8x20 | 4 |
| 10. Polt / bolt / болт / Bolzen M8x25 | 14 |
| 11. Mutter / nut / гайка / Mutter M8 | 4 |
| 12. Seib / washer / шайба / Scheibe 6,6x22x2 | 8 |
| 13. Seib / washer / шайба / Scheibe 8,4x16x1,6 | 18 |
| 14. Seib / washer / шайба / Scheibe 8,4x24x2 | 4 |
| 15. Vedruseib / spring washer / пружинная шайба / Federnscheibe A8 | 14 |
| 16. Laterna kinnituskronstein / lamp fixing bracket / крепежный кронштейн лампы / Lampenbefestigungsklammer | 6 |

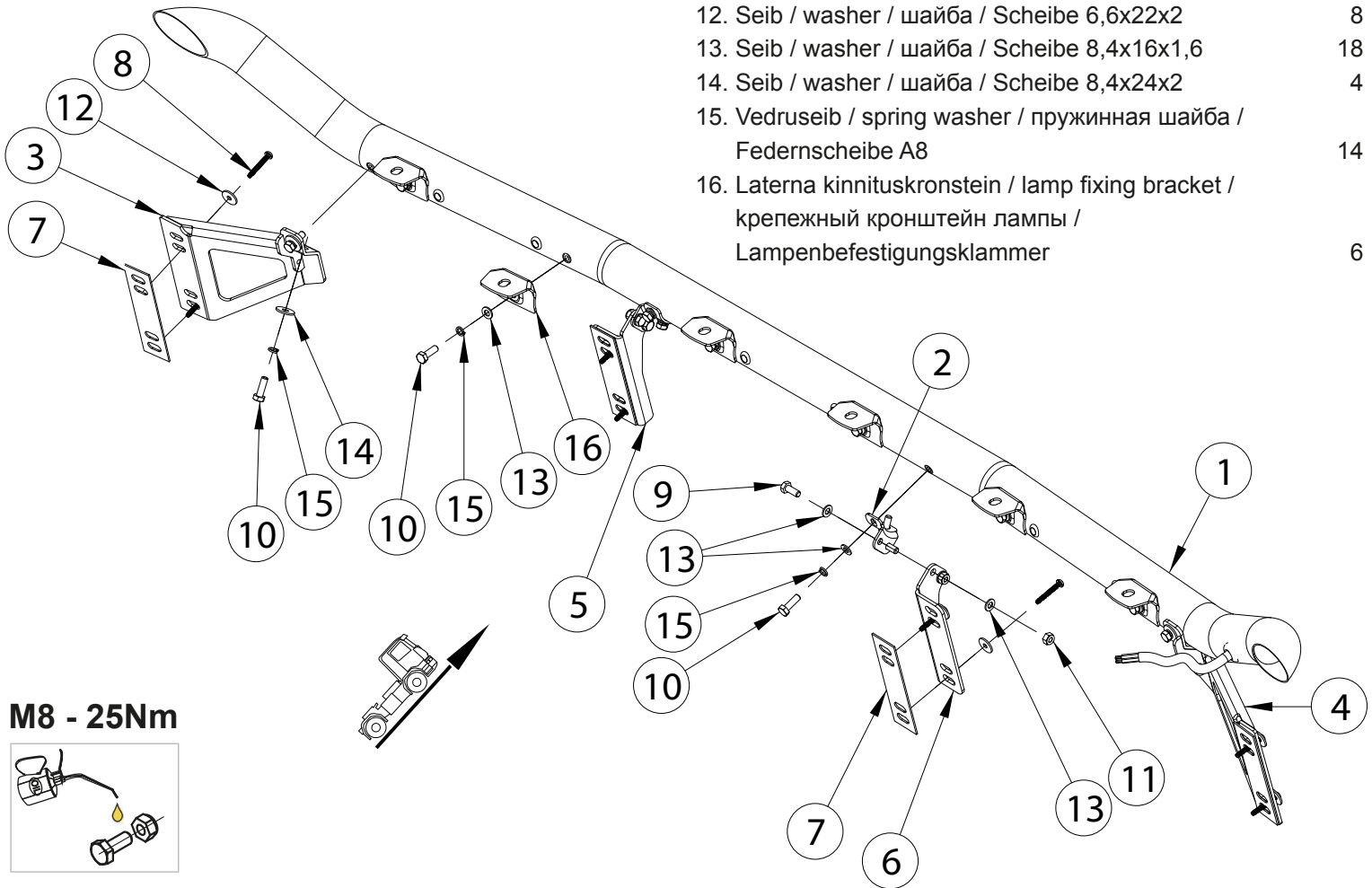

M8 - 25Nm

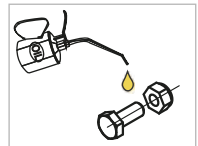

Kaal / Weight / Масса / Gewicht: 10,3 kg

Paigaldusaeg ilma elektritöödetä / Time of mounting w/o wiring works / Время установки без электромонт. работ / Einbauzeit ohne elektrische arbeit: 45 min

Vajalikud tööriistad / Required Tools / Необходимые инструменты / Benötigte Werkzeuge



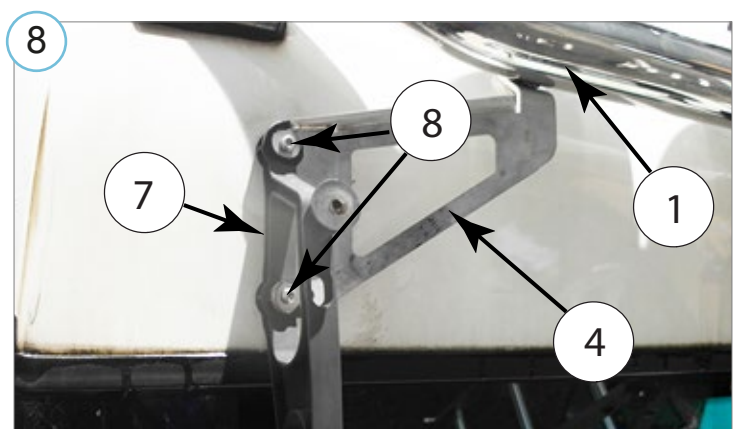
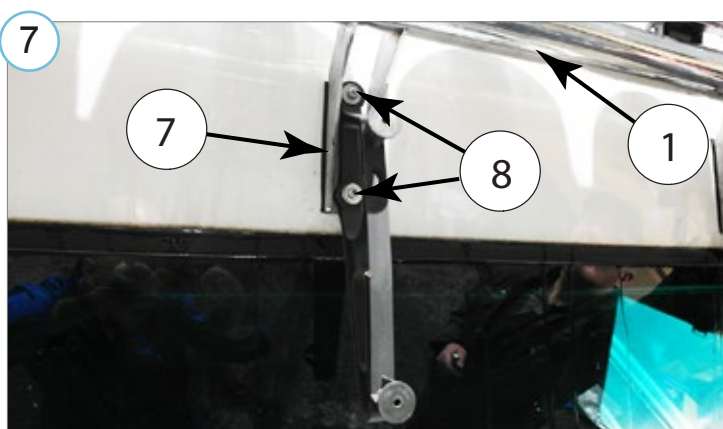
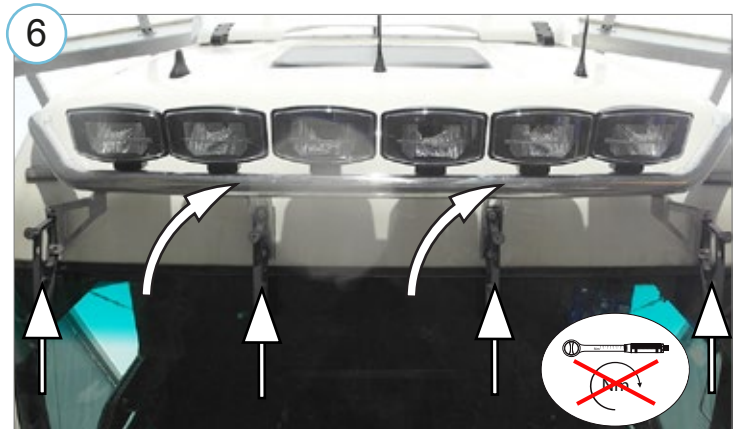
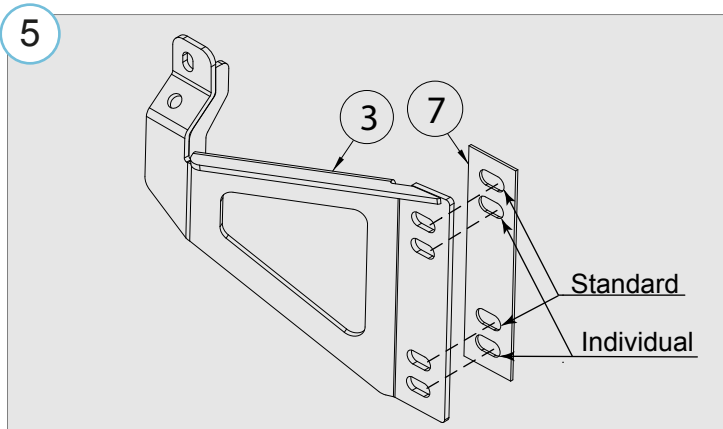
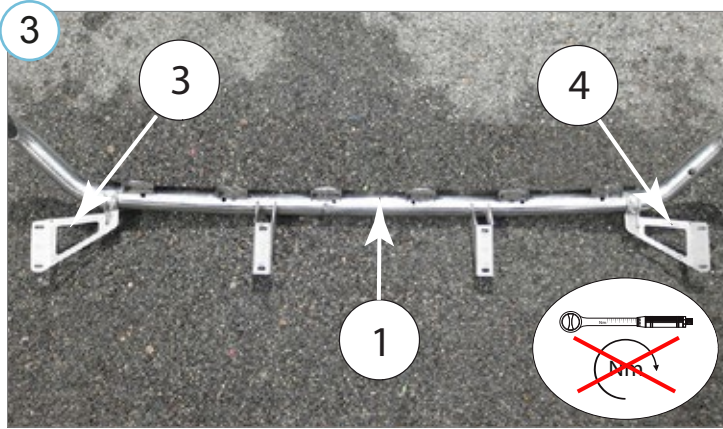
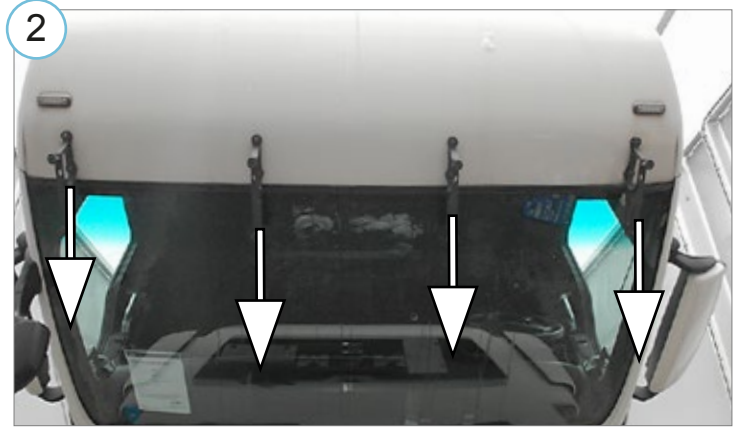
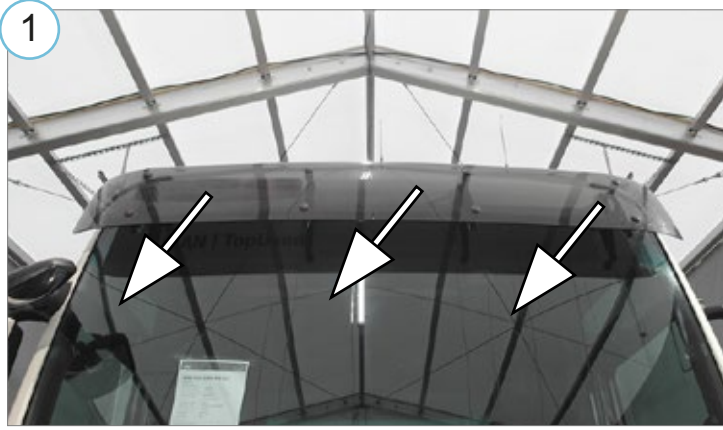

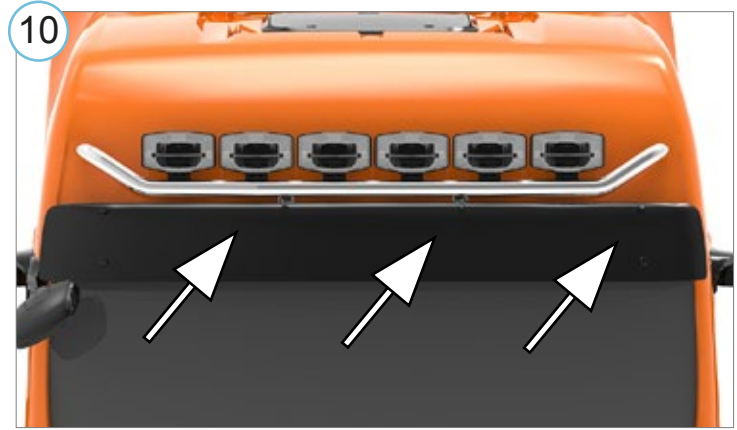
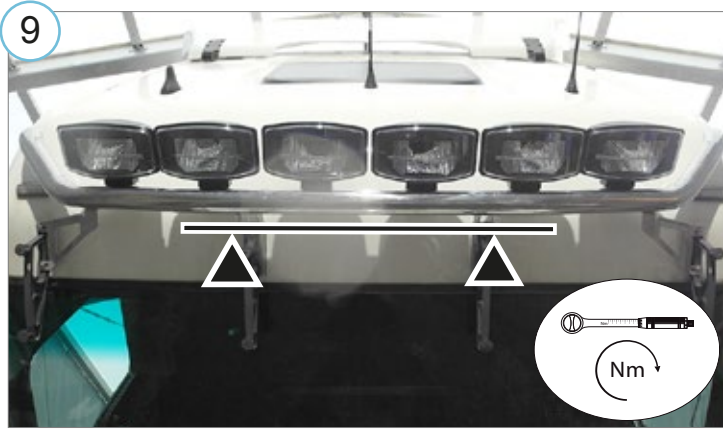

11 Elektrihendused teostada kvalifitseeritud autoelektriku poolt

Installation of the lights can be carried out by qualified electrician only

Монтаж огней может быть выполнено только квалифицированным электриком

Die Installation der Lichter können durchgeführt werden durch Elektrofachkraft

12

10 000 km

1x

Switching pattern of the lights of the holder.

Juhul kui lampide A+B+C koguvõimsus ületab 280 W tuleb juhtmesarja võimalikke signaali juhtmeid (A/B) kasutada täiendavaks maanduseks! Erinevate laternate võimalik samaaegsete lülituste arv väheneb.

If the total wattage of the headlights A+B+C exceeds 280 W, the signal cables of the wiring harness (A/B) must be used as additional grounding! The number of possible simultaneous switching of different headlamps is decreasing.

Если общая мощность фар A+B+C превышает 280 Вт, сигнальные кабели жгута проводов (A/B) следует использовать в качестве дополнительного заземления! Количество возможных одновременных переключений различных фар уменьшается.

Falls die Gesamtleistung der Scheinwerfer A+B+C 280 W übersteigt, sind die eventuellen Signalkabel des Kabelbaums (A/B) als zusätzliche Erdung zu verwenden! Die Anzahl möglicher gleichzeitiger Schaltungen verschiedener Scheinwerfer verringert sich.

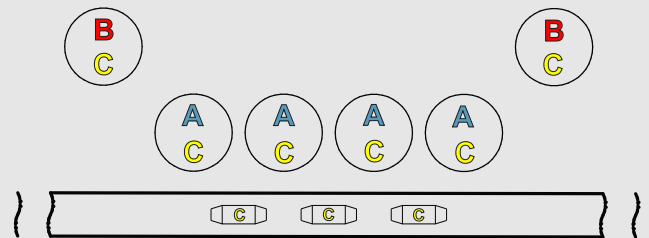

possible switch ON position	Harness ID number references / Juhtmesarjade viited			
	5G1,5	3G1,0 B	3G1,0 A	2G0,75
C+	1	1	1	2
A -	Gr/y	Gr/y		1
B +	2		2	
A +	3	2		
B -	4		Gr/y	