

Volvo FH Aero 2024-

Art. 86872270, 86872271, 86872370, 86872371

Laternakandur CLASSIC | Lamp holder CLASSIC | Scheinwerferbügel CLASSIC

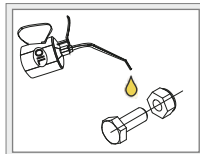

1. Laternakandur / lamp holder / Scheinwerferbügel	1
2. Kronstein / bracket / Konsole	1
3. Kronstein / bracket / Konsole	1
4. Käsikruvi / thumbscrew / Flügelschraube	2
5. Polt / bolt / Bolzen	2
6. Kronstein / bracket / Konsole	1
7. Kronstein / bracket / Konsole	1
8. Toru / pipe / Rohr	4
9. Polditav kronstein / bolt bracket / Bolzenhalterung	2
10. Laternaalus / lamp fixing bracket / Lampenbefestigung sklammer	4
11. U-polt / U-bolt / U-bolzen	2
12. Kronstein / bracket / Konsole	1
13. Kronstein / bracket / Konsole	1
14. Kronstein / bracket / Konsole	1
15. Kronstein / bracket / Konsole	1
16. Puks / bushing / Buchse	1
17. Polt / bolt / Bolzen M6x16 DIN933-A2	4
18. Polt / bolt / Bolzen M6x30 DIN933-A2	1
19. Polt / bolt / Bolzen M6x55 DIN931-A2	2
20. Polt / bolt / Bolzen M8x20 DIN7380-A2	20
21. Polt / bolt / Bolzen M8x45 DIN933-A2	4
22. Mutter / nut / Mutter M6 DIN985-A2	6
23. Mutter / nut / Mutter M8 DIN985-A2	12
24. Seib / flat washer / Scheibe 6,4x12x1,6	13
25. Seib / flat washer / Scheibe 8,4x16x1,6	22
26. Seib / flat washer / Scheibe 8,4x24x2	10
27. Vedruseib / spring washer / Federnscheibe A6	1
28. Vedruseib / spring washer / Federnscheibe A8	18

A2 / A4
M6 - 7 Nm
M8 - 17 Nm

Külmkeevituse vältimiseks kasutada külmkeevitusvastast määret või mootoriõli.
To prevent cold welding, use cold weld grease or engine oil.
Verwenden Sie geeignetes Fett oder Motoröl, um die Kaltverschweißung zu verhindern.

Kaal / Weight / Gewicht: 12,6 kg

Paigaldusaeg ilma elektritöödeta / Time of mounting w/o wiring works / Einbauzeit ohne elektrische arbeit: 90 min

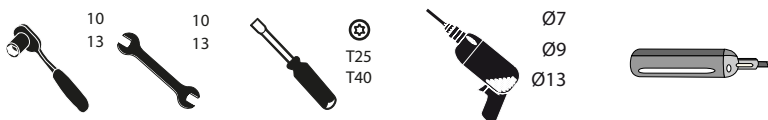
Vajalikud tööriistad / Required Tools / Benötigte Werkzeuge

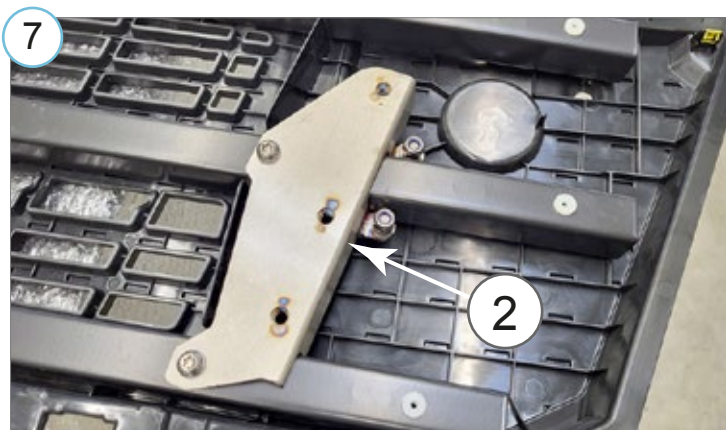
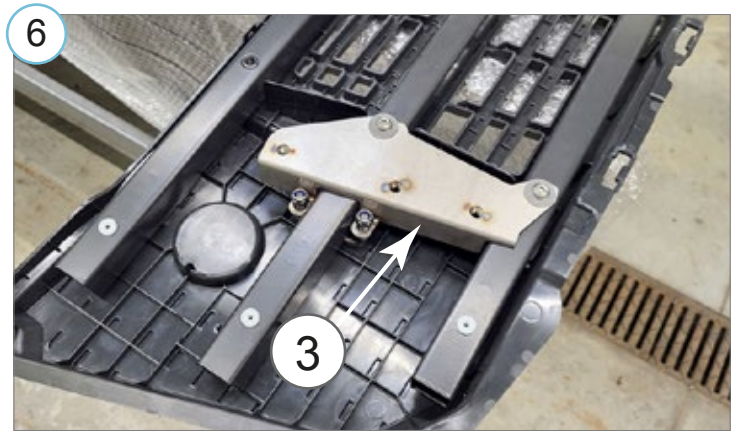
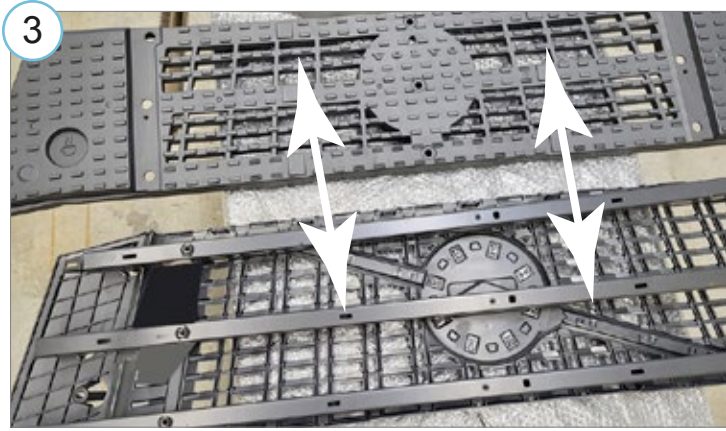
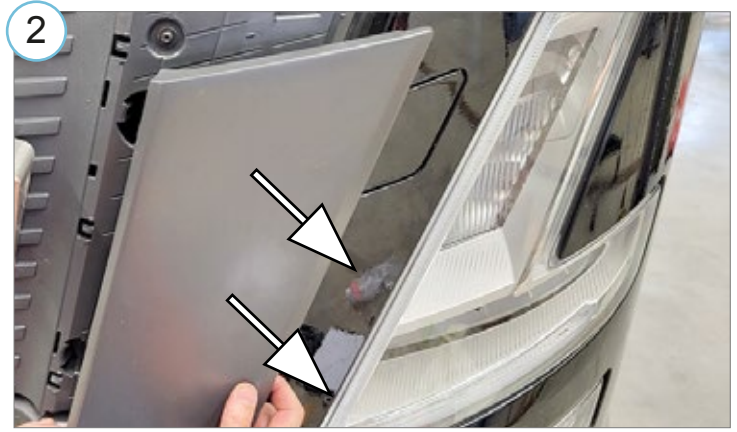
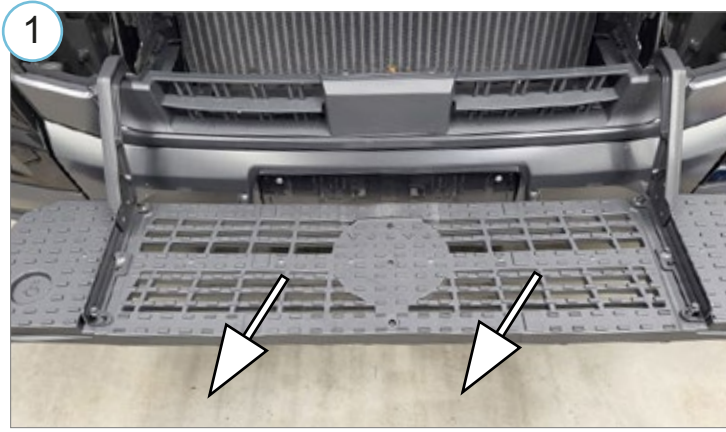



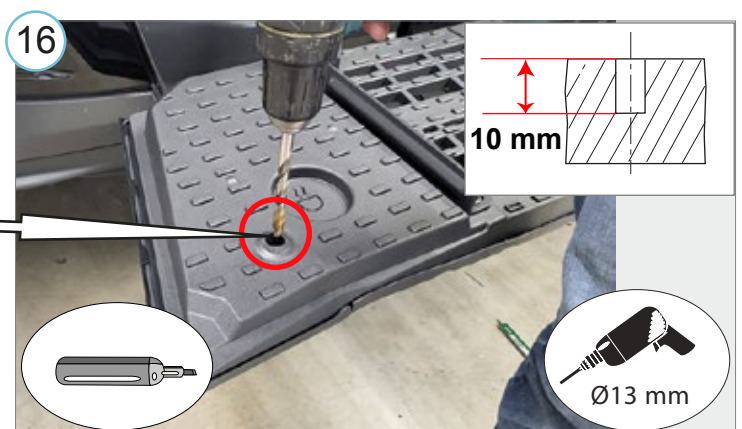
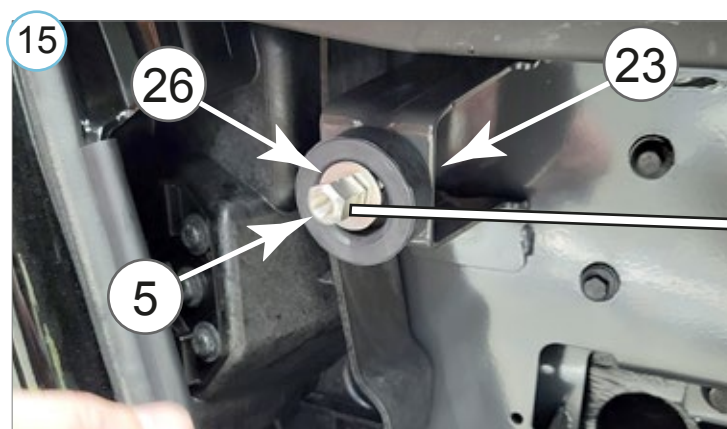
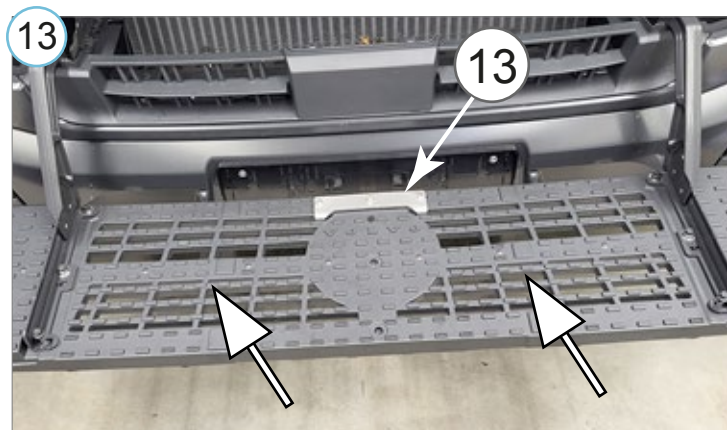
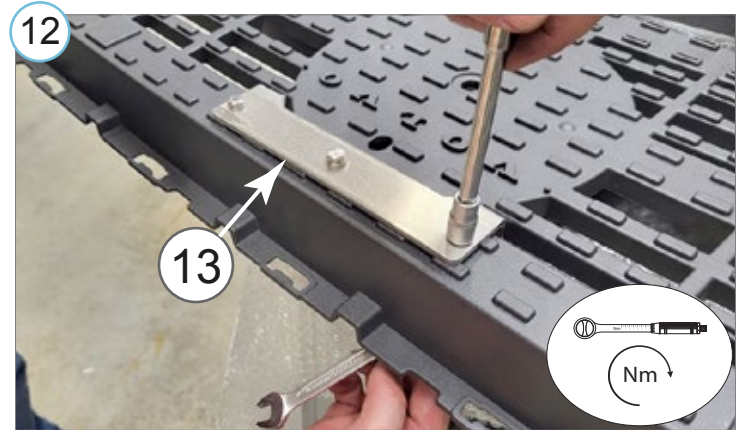
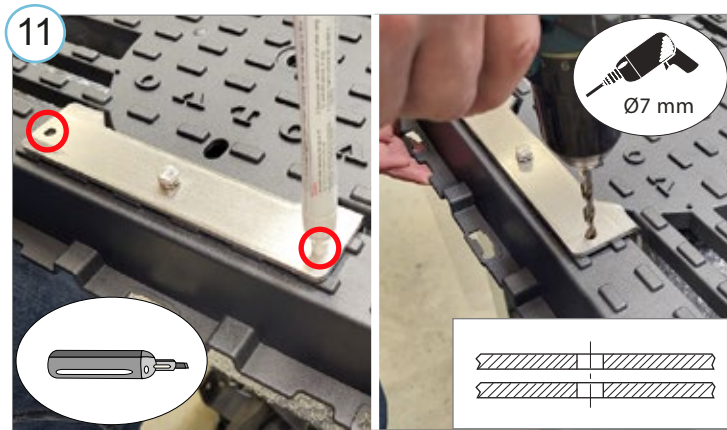
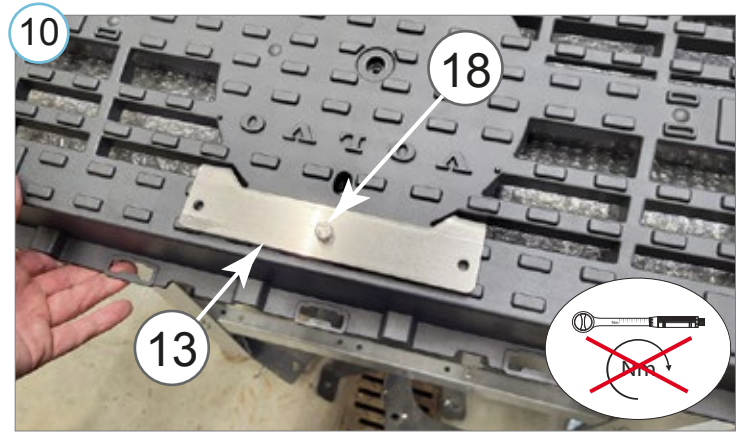
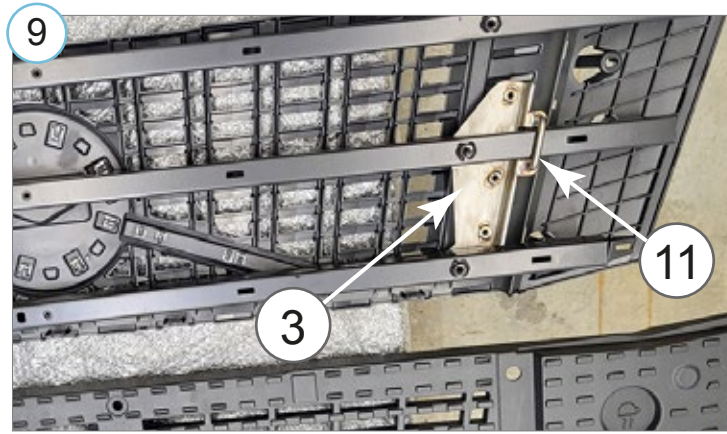

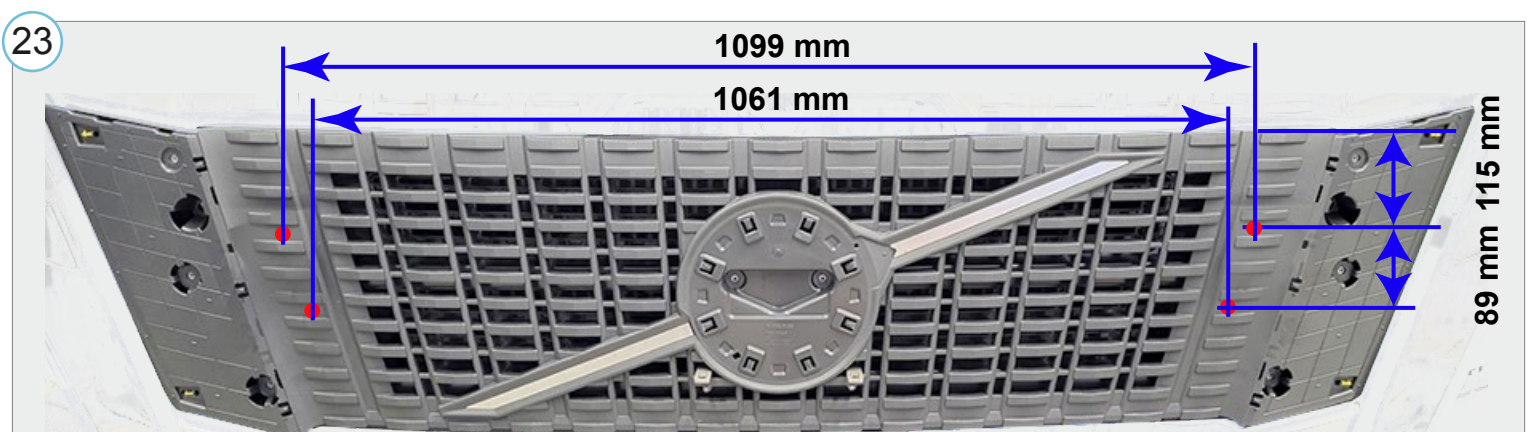
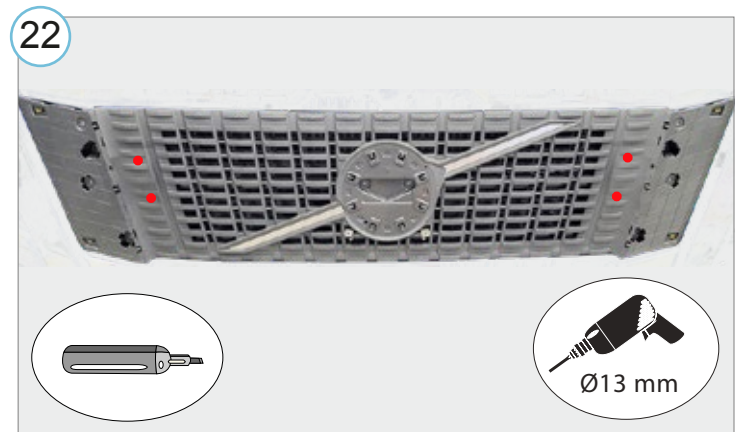
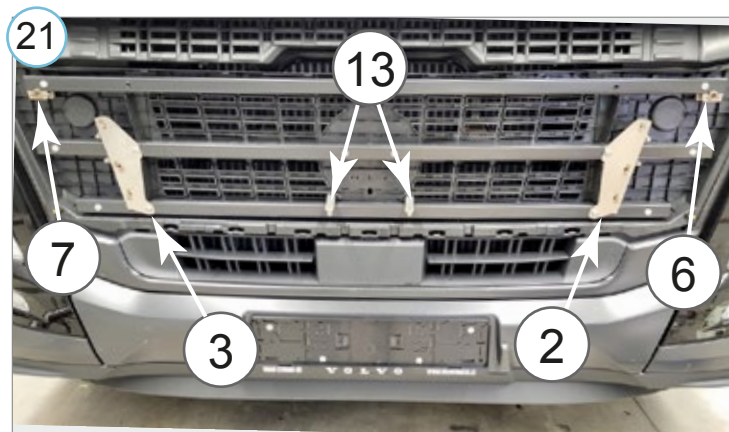
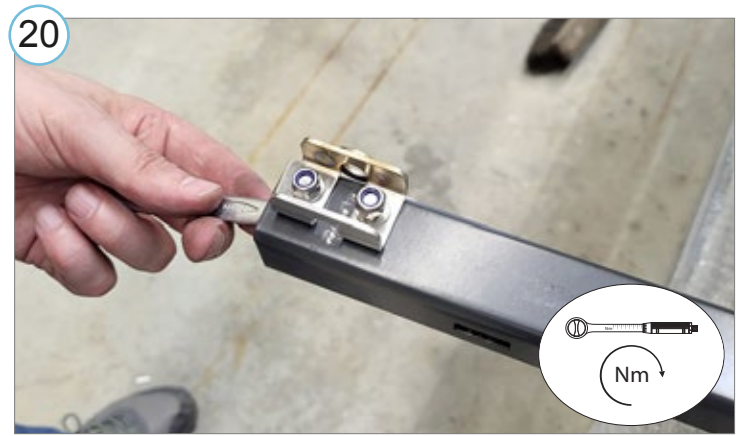
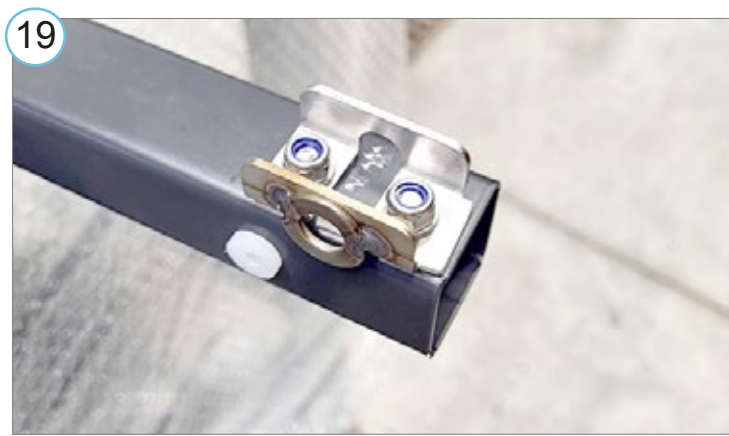
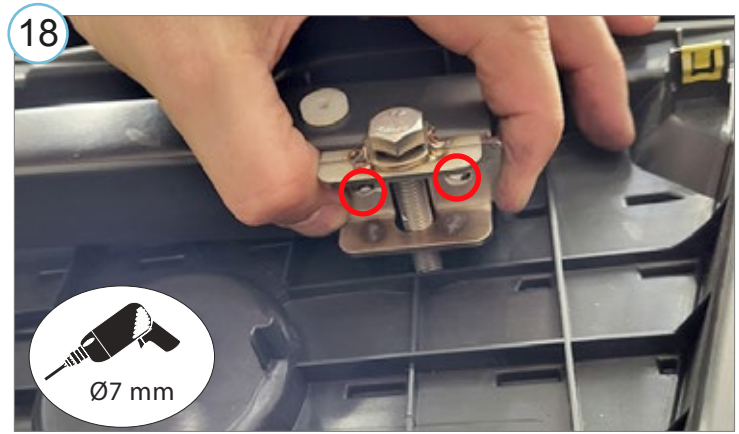
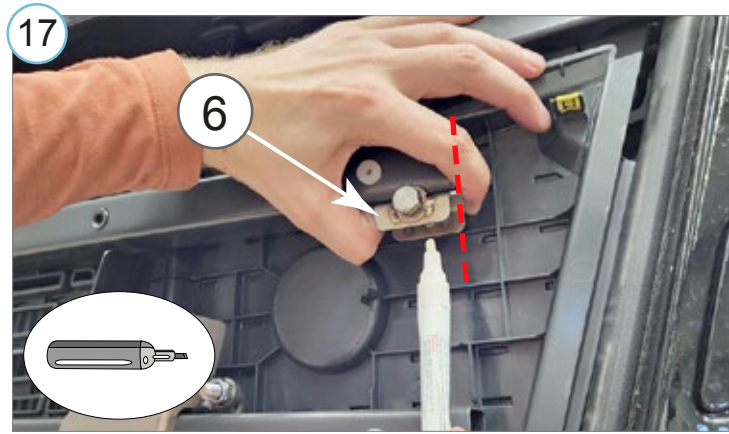

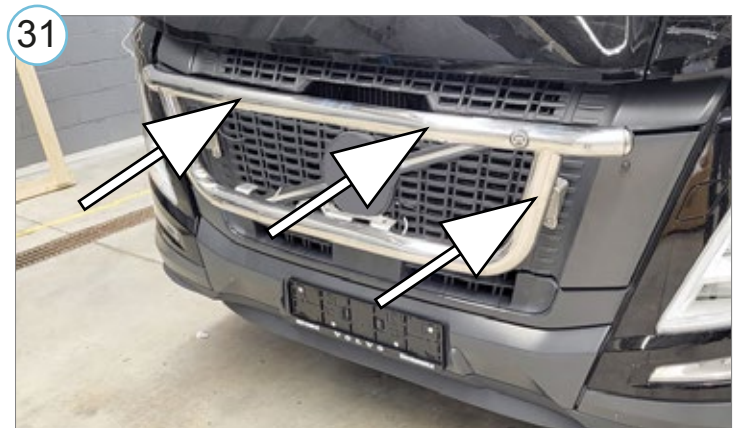
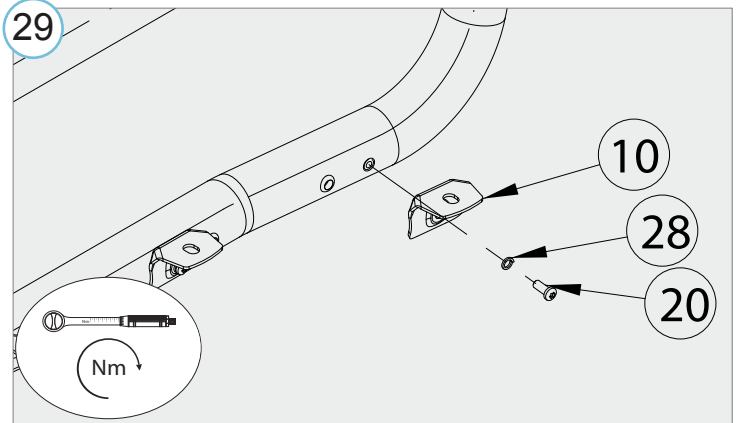
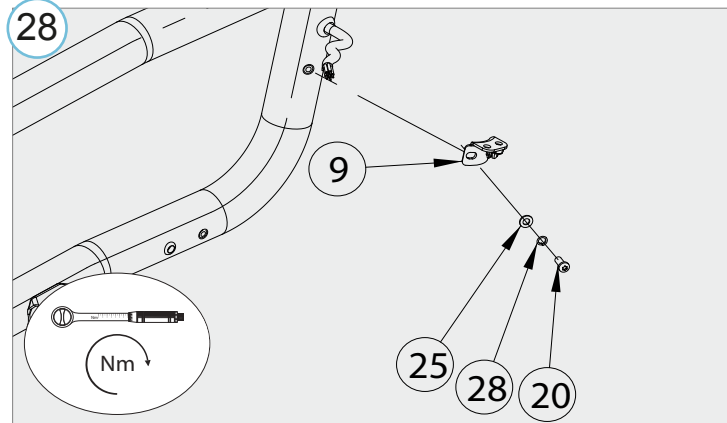
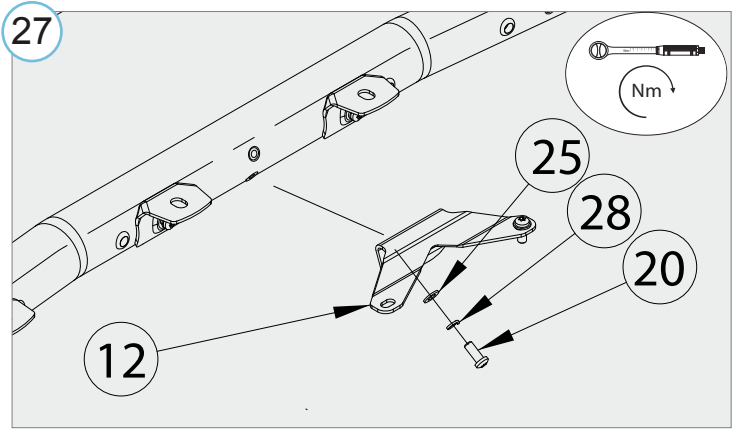
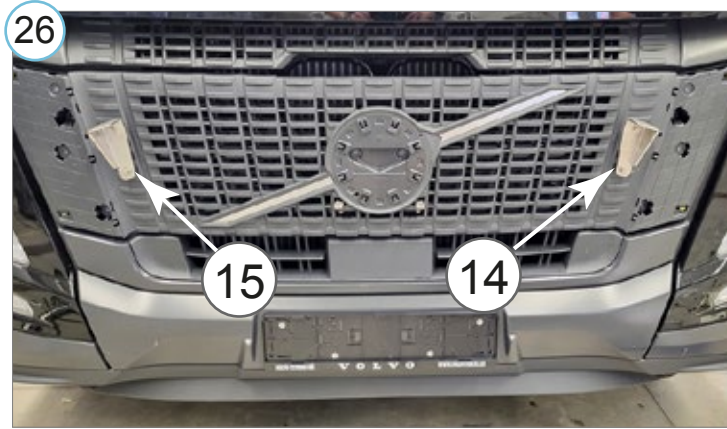
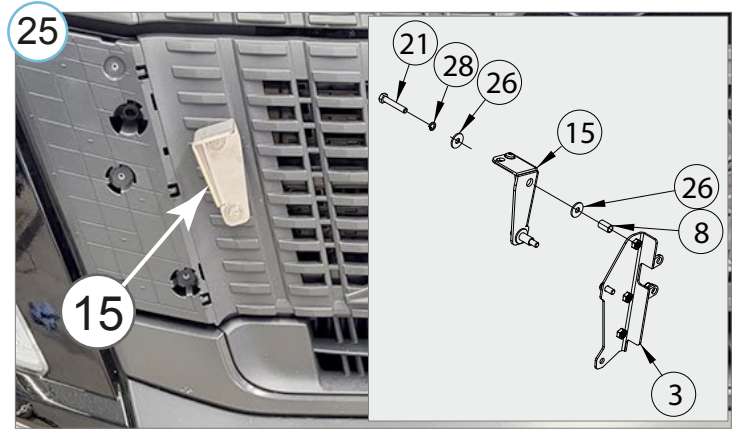
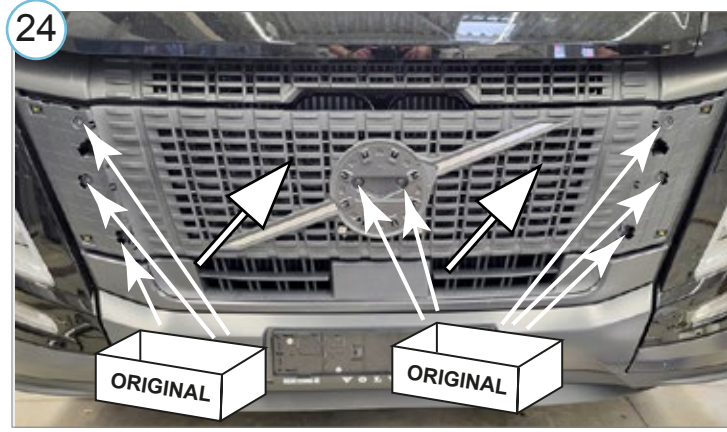

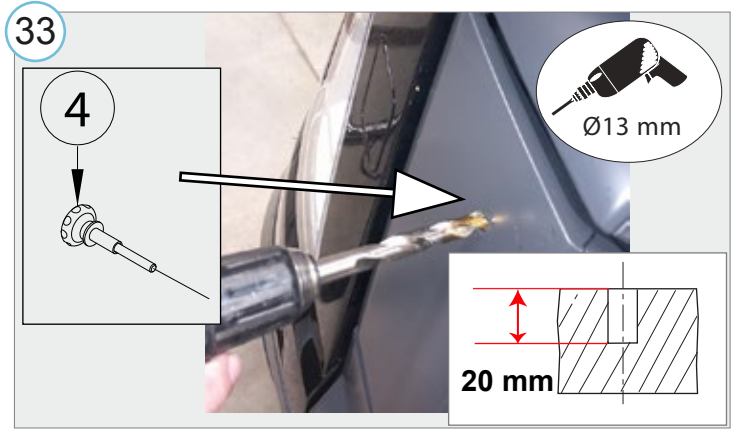
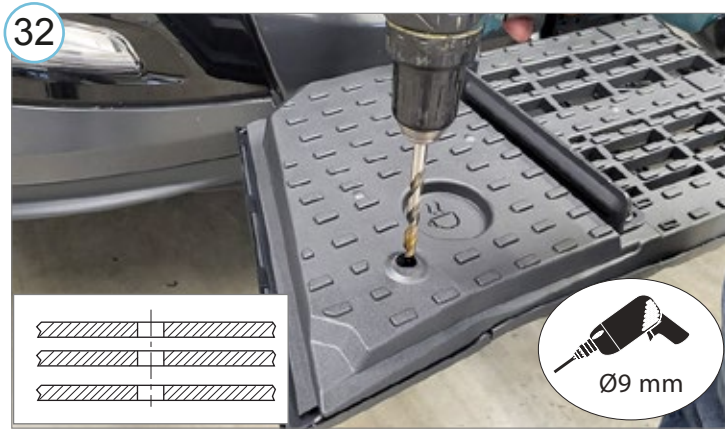

35

Elektriühendused teostada kvalifitseeritud autoelektriku poolt

Installation of the lights can be carried out by qualified electrician only

Die Installation der Lichter können durchgeführt werden durch Elektrofachkraft

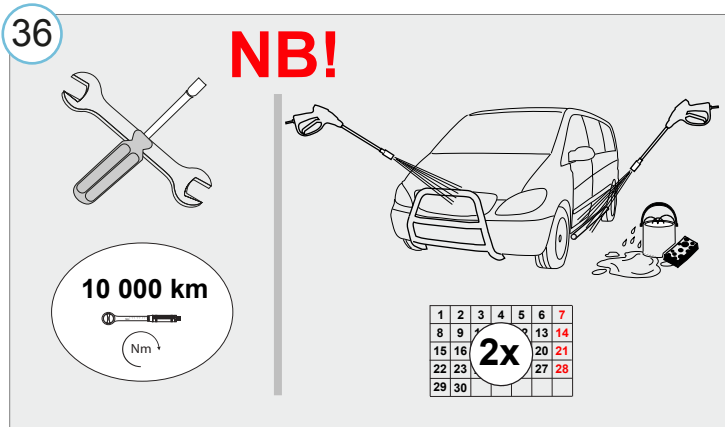

- Kui METEC toode ei vasta Teie ootustele või kui on tegemist toote ebapiisava kvaliteediga, siis pretensioonid esitada lehel www.metec.ee
- If the METEC product does not meet Your expectations or if it is a product of insufficient quality, then you can submit a claim at www.metec.ee
- Wenn METEC Produkt nicht Ihren Erwartungen entspricht oder wenn es um Qualitätsmängel geht, dann bitte die Ansprüche auf Seite www.metec.ee einreiche

Lisa / extra / Extra

