

Volvo FH Aero 2024- (without spoiler)

Art. 86871670, 86871671

Kaitseraud OUTLAND | Cattleguard OUTLAND | LKW Bullfänger OUTLAND

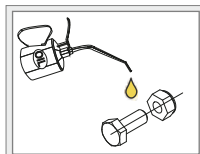

1. Laternakandur / lamp holder / Scheinwerferbügel	1
2. Kronstein / bracket / Konsole	1
3. Kronstein / bracket / Konsole	1
4. T-polt / T-bolt / T-bolzen	2
5. Kronstein / bracket / Konsole	1
6. Kronstein / bracket / Konsole	1
7. Kronstein / bracket / Konsole	1
8. Kronstein / bracket / Konsole	1
9. Laternaalus / lamp fixing bracket / Lampenbefestigung sklammer	4
10. Toru / pipe / Rohr 50x50	2
11. Polt / bolt / Bolzen M8x20 DIN7380-A2	4
12. Polt / bolt / Bolzen M8x30 DIN912-8.8-galZn	2
13. Polt / bolt / Bolzen M10x25 DIN933-A2	4
14. Polt / bolt / Bolzen M12x80 DIN933-galZn	4
15. Mutter / nut / Mutter M10 DIN934-A2	4
16. Mutter / nut / Mutter M12 DIN985-galZn	4
17. Seib / flat washer / Scheibe 8,4x16x1,6	2
18. Seib / flat washer / Scheibe 10,5x30x2,5	10
19. Seib / flat washer / Scheibe 13x24x2,5	8
20. Vedruseib / spring washer / Federnscheibe A8	6
21. Vedruseib / spring washer / Federnscheibe A10	6

Külmkeevituse vältimiseks kasutada külmkeevitusvastast määret või mootoriõli.
To prevent cold welding, use cold weld grease or engine oil.
Verwenden Sie geeignetes Fett oder Motoröl, um die Kaltverschweißung zu verhindern.

Kaal / Weight / Gewicht: 57,9 kg

Paigaldusaeg ilma elektritöödeta / Time of mounting w/o wiring works / Einbauzeit ohne elektrische arbeit: 60 min

Vajalikud tööriistad / Required Tools / Benötigte Werkzeuge



A2 / A4	Zn
M8 - 17 Nm	M8 - 47 Nm
M10 - 33 Nm	M12 - 81 Nm
	M16 - 277 Nm



Volvo FH Aero 2024- (without spoiler)

Kaitseraud OUTLAND | Cattleguard OUTLAND | LKW Bullfänger OUTLAND

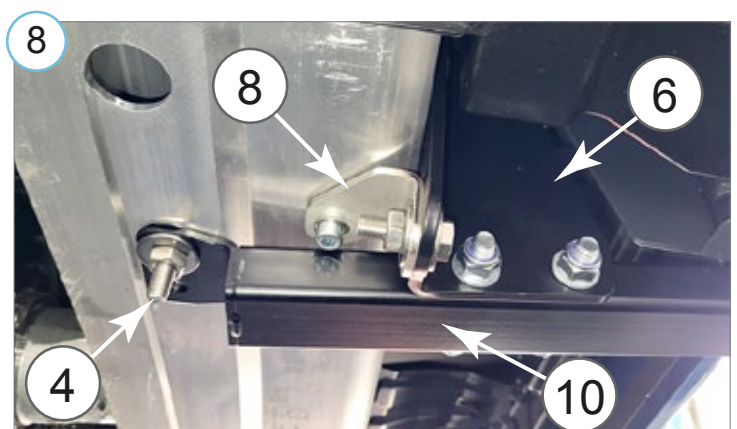
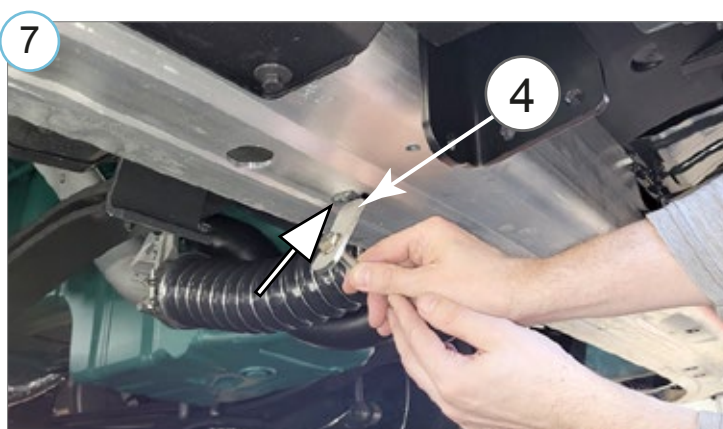
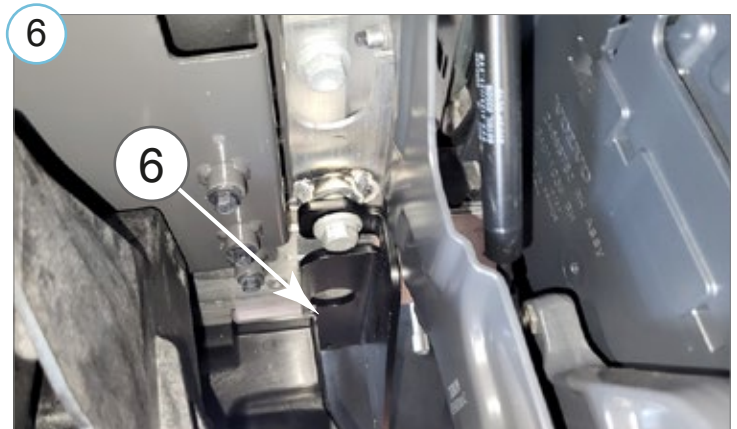
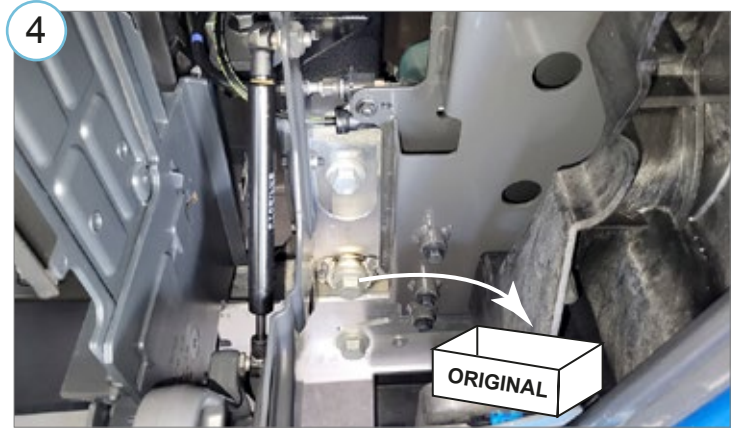
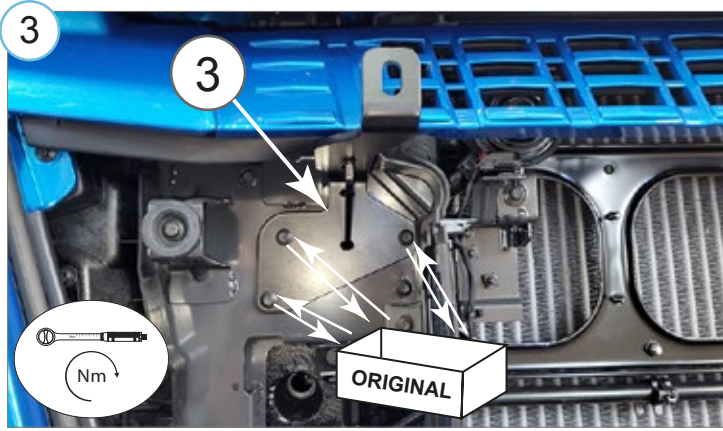
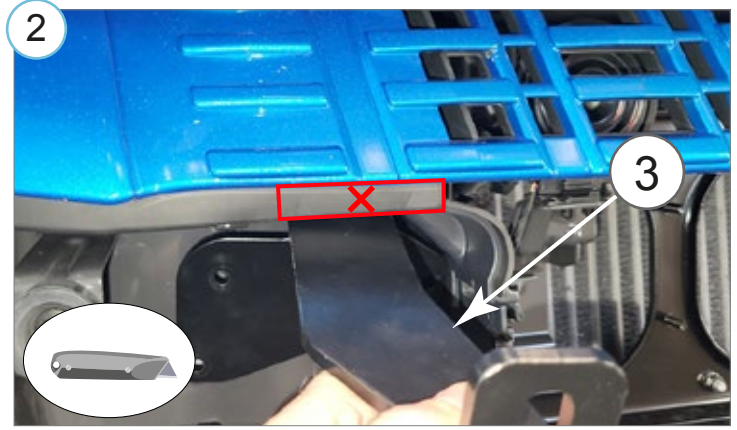
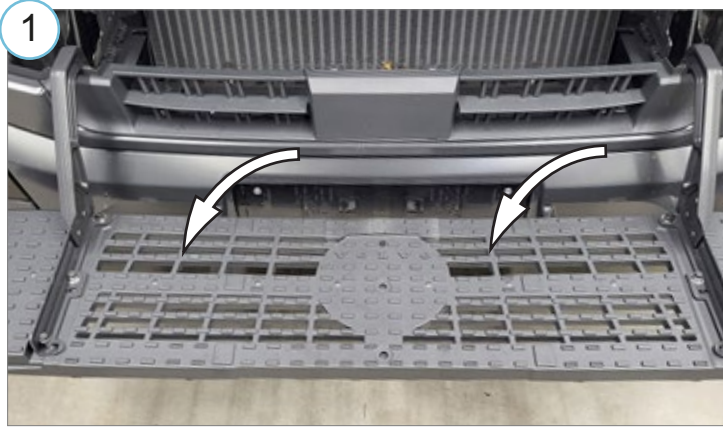

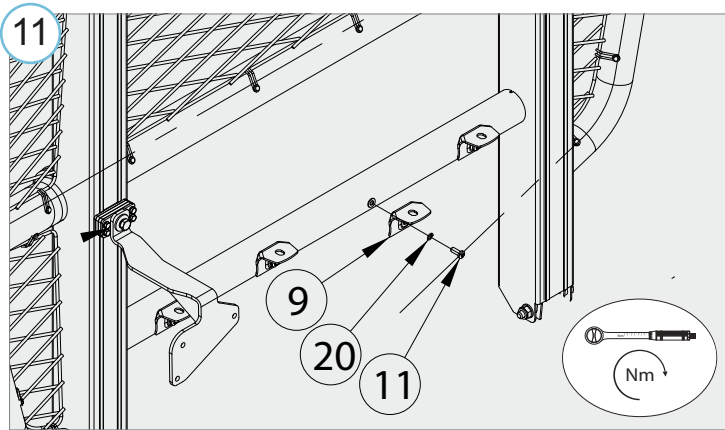
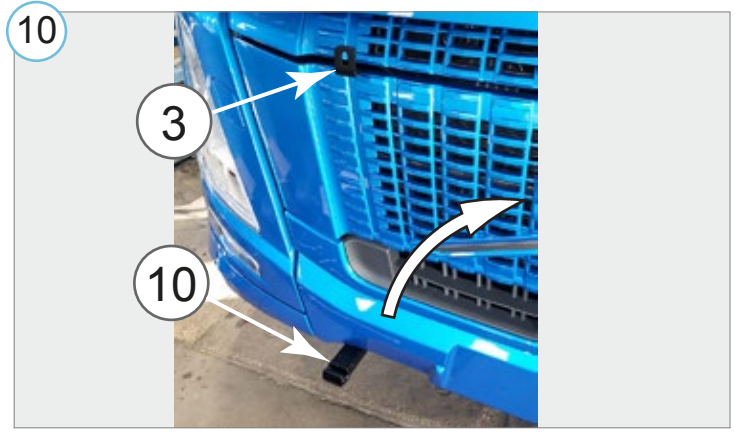
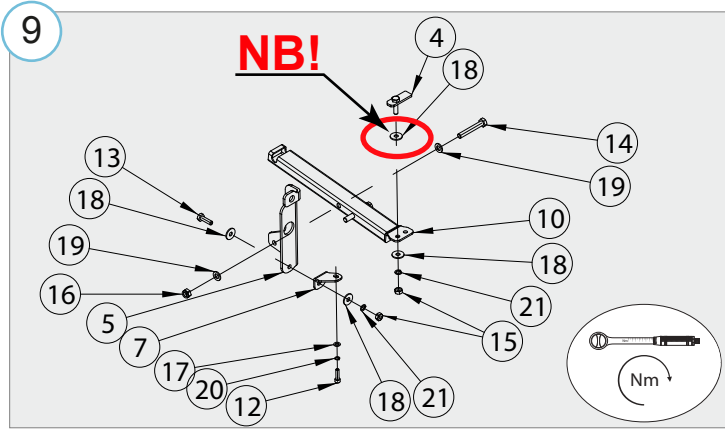

13

Elektriühendused teostada kvalifitseeritud autoelektriku poolt

Installation of the lights can be carried out by qualified electrician only

Die Installation der Lichter können durchgeführt werden durch Elektrofachkraft

14

NB!

10 000 km

1	2	3	4	5	6	7
8	9	10	11	12	13	14
15	16	17	18	19	20	21
22	23	24	25	26	27	28
29	30	31	32	33	34	35

2x

- Kui METEC toode ei vasta Teie ootustele või kui on tegemist toote ebapiisava kvaliteediga, siis pretensioonid esitada lehel www.metec.ee
- If the METEC product does not meet Your expectations or if it is a product of insufficient quality, then you can submit a claim at www.metec.ee
- Wenn METEC Produkt nicht Ihren Erwartungen entspricht oder wenn es um Qualitätsmängel geht, dann bitte die Ansprüche auf Seite www.metec.ee einreiche

Lisa / extra / Extra

