



VW T7 2022-

Art. 840855

Nordicbar | Nordicbar | Нордикбар | Nordicbar



1. Kontuur / contour / контур / Kontur	1
2. Toru / pipe / труба / Rohr 50x50	2
3. Kronstein / bracket / кронштейн / Konsole	1
4. Kronstein / bracket / кронштейн / Konsole	1
5. U-profiil / U-profile / U-профиль / U-Profil	2
6. Kronstein / bracket / кронштейн / Konsole	2
7. Laternaalus / lamp fixing bracket / крепежный кронштейн лампы / Lampenbefestigungsklammer	3
8. Kronstein / bracket / кронштейн / Konsole	1
9. Kronstein / bracket / кронштейн / Konsole	1
10. Kronstein / bracket / кронштейн / Konsole	1
11. Kronstein / bracket / кронштейн / Konsole	1
12. Polt / bolt / болт / Bolzen M8x20 DIN7380-A2	4
13. Polt / bolt / болт / Bolzen M8x20 DIN933-A2	17
14. Polt / bolt / болт / Bolzen M10x25	2
15. Polt / bolt / болт / Bolzen M10x30	4
16. Mutter / nut / гайка / Mutter M8	10
17. Mutter / nut / гайка / Mutter M10	4
18. Seib / flat washer / шайба / Scheibe 8,4x16x1,6	23
19. Seib / flat washer / шайба / Scheibe 8,4x24x2	8
20. Seib / flat washer / шайба / Scheibe 10,5x20x2	8
21. Seib / flat washer / шайба / Scheibe 10,5x30x2,5	2
22. Vedruseib / spring washer / пружинная шайба / Federnscheibe A8	11
23. Vedruseib / spring washer / пружинная шайба / Federnscheibe A10	2
24. Paindiv kaablikaitsetu / flexible cable protection tube / гибкая защитная труба кабеля / flexibler Kabelschutzschlauch	1

M8 - 25 Nm

M10 - 50 Nm

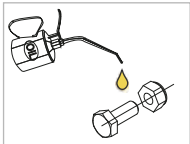

Kaal / Weight / Масса / Gewicht: 10,6 kg

Raigaldusaeg ilma elektritöödeteta / Time of mounting w/o wiring works / Время установки без электромонт. работ / Einbauzeit ohne elektrische arbeit: 90 min

Vajalikud tööriistad / Required Tools / Необходимые инструменты / Benötigte Werkzeuge



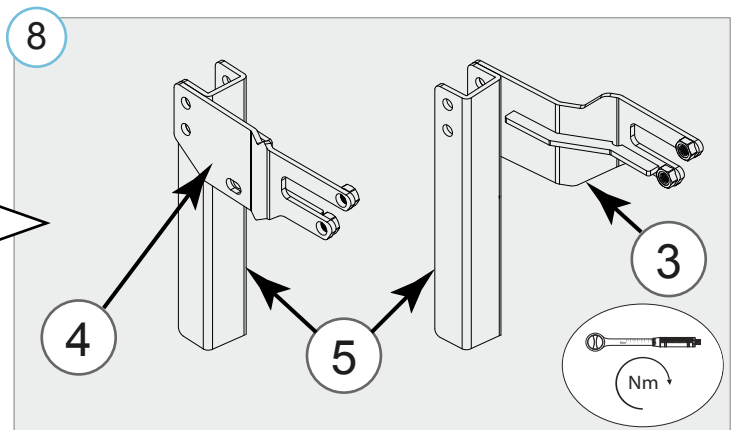
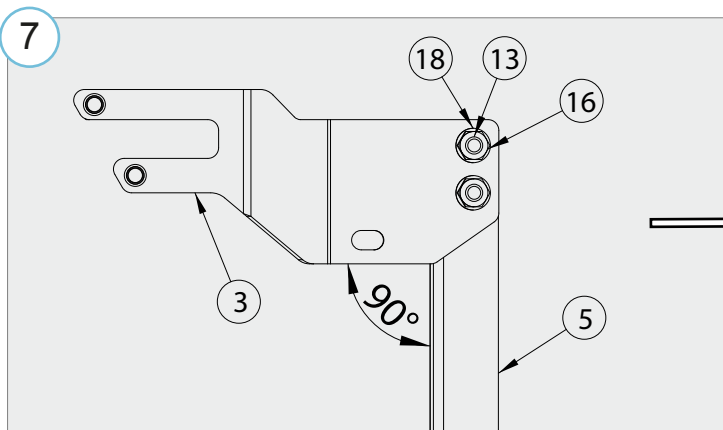
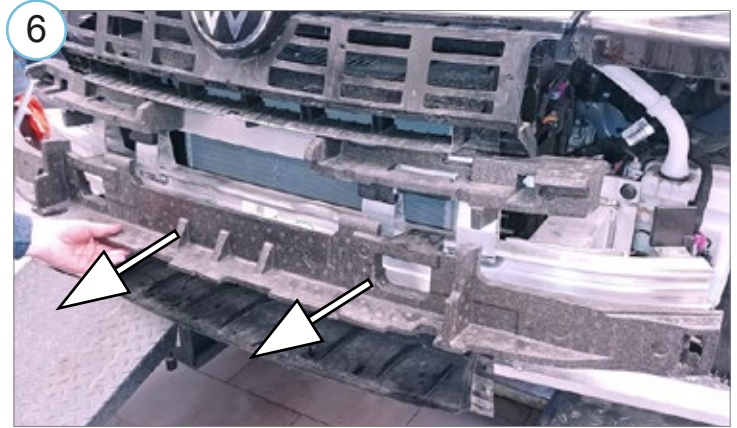
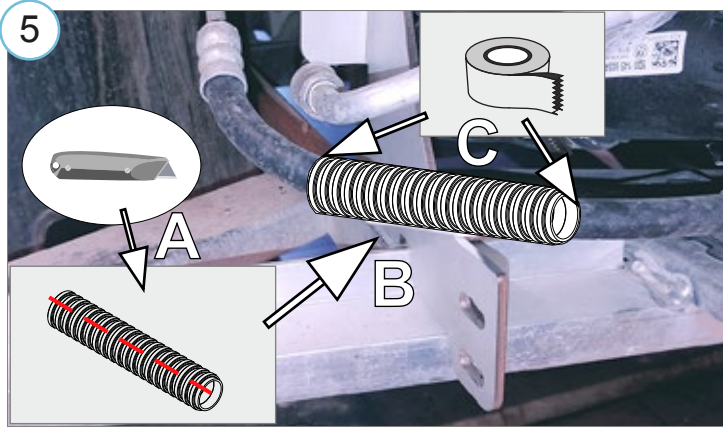
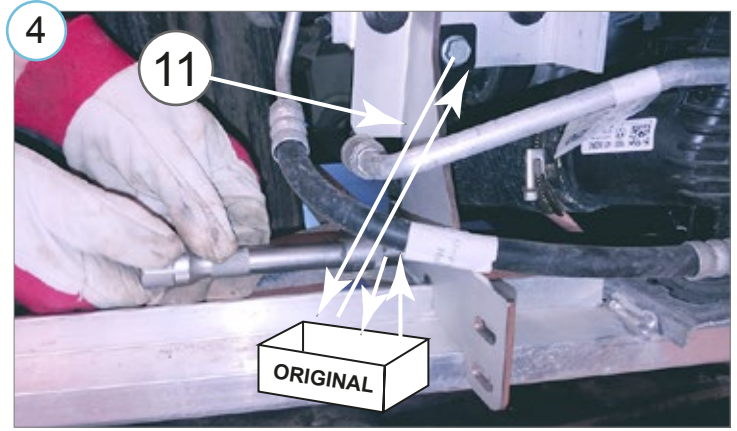
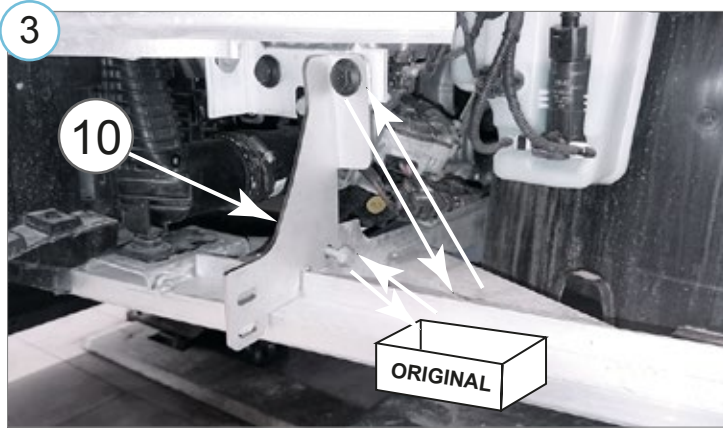
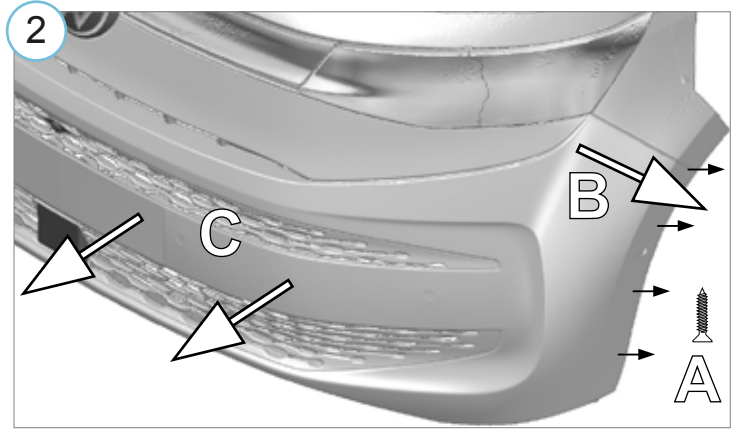

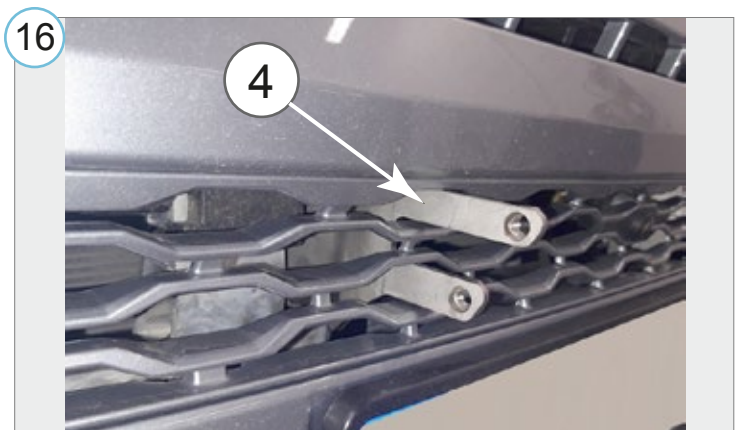
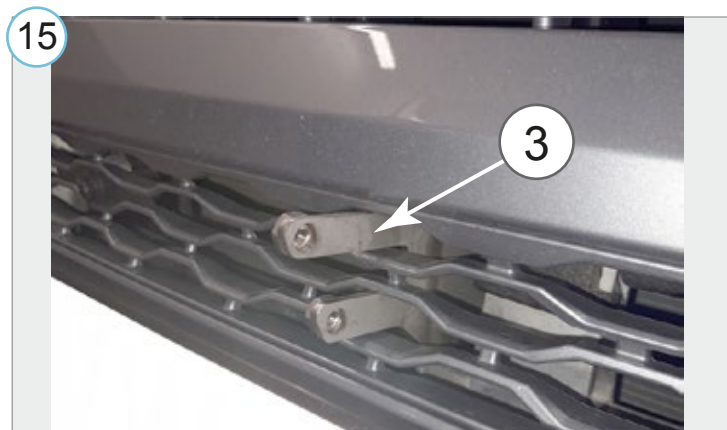
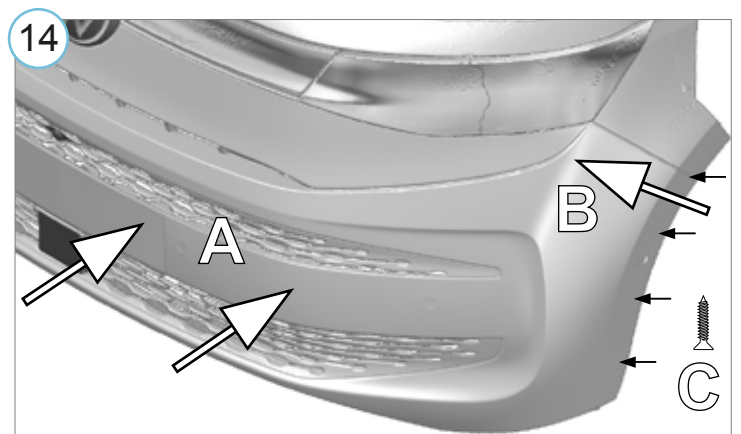
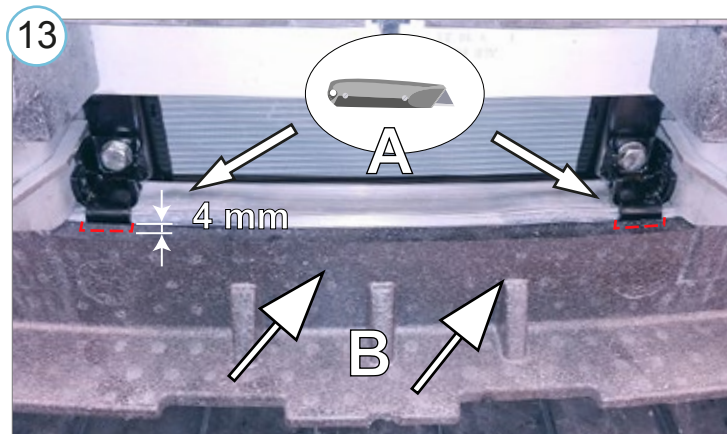
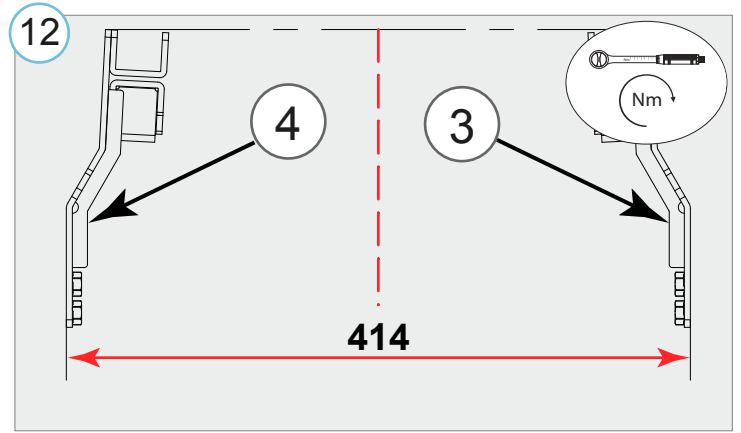
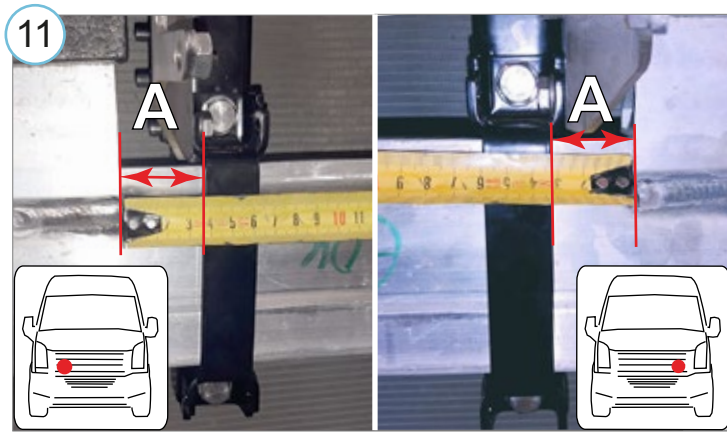
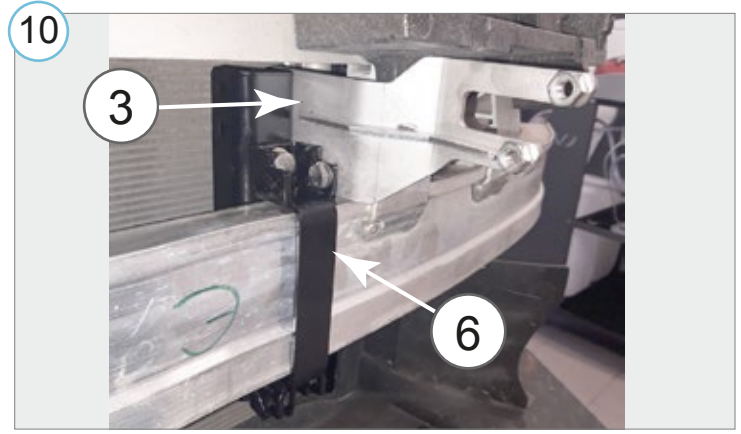
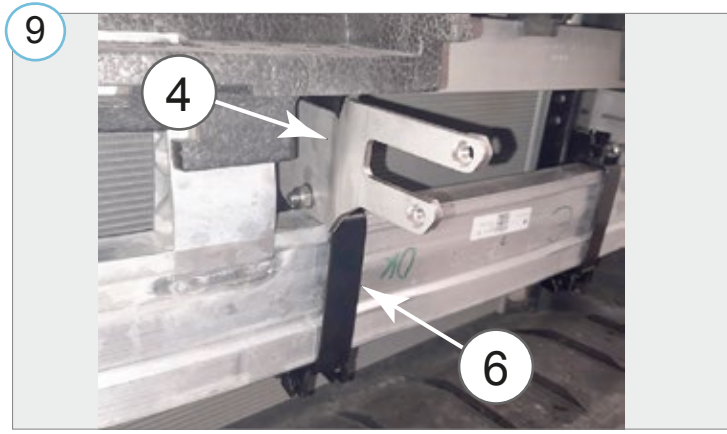

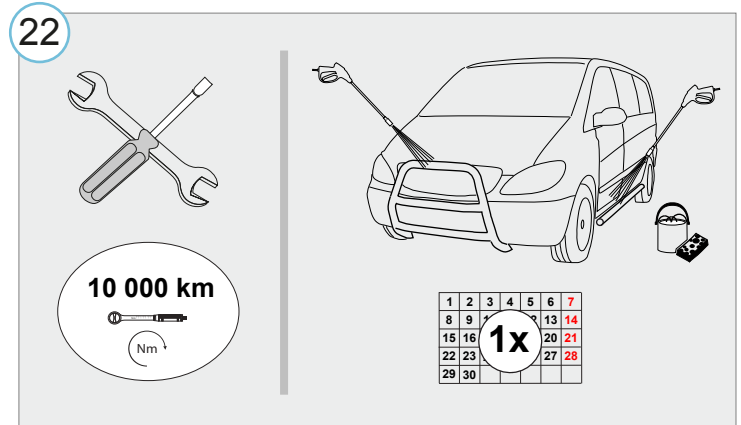
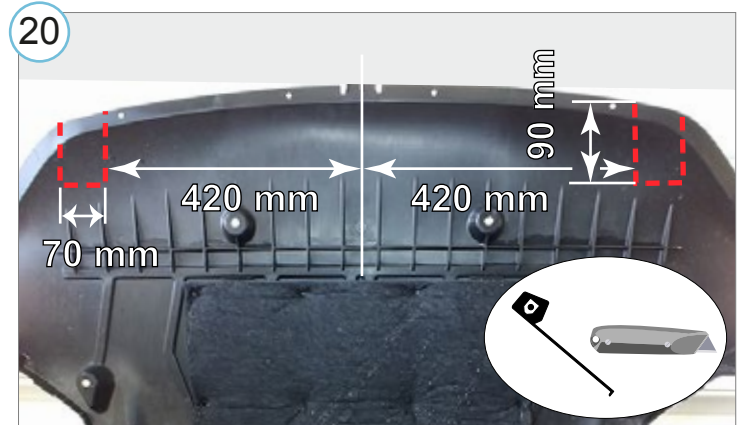
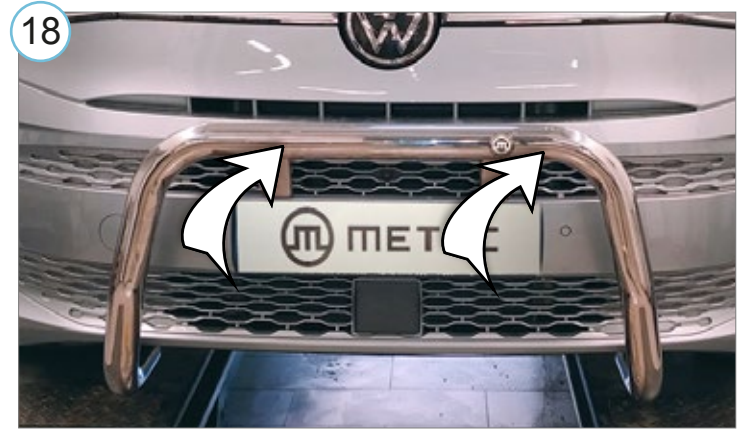
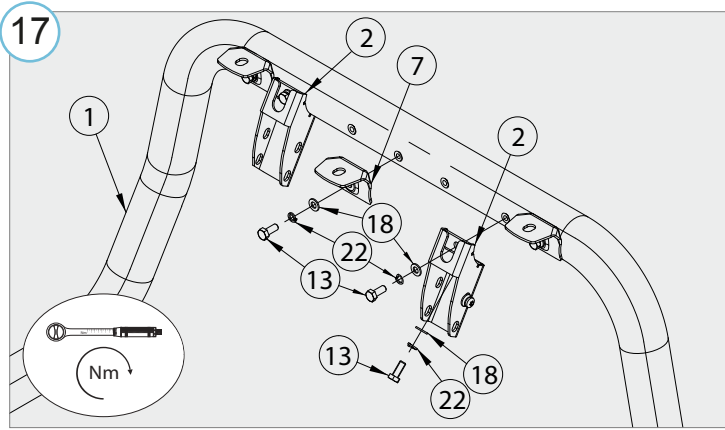

23 Elektrihendused teostada kvalifitseeritud autoelektriku poolt

Installation of the lights can be carried out by qualified electrician only

Монтаж огней может быть выполнено только квалифицированным электриком

Die Installation der Lichter können durchgeführt werden durch Elektrofachkraft

• Kui METEC toode ei vasta Teile ootustele või kui on tegemist toote ebapiisava kvaliteediga, siis pretensioonid esitada lehel www.metec.ee
 • If the METEC product does not meet Your expectations or if it is a product of insufficient quality, then you can submit a claim at www.metec.ee
 • Если METEC продукт не соответствует Вашим ожиданиям или это продукт недостаточного качества, то претензию предъявить можно на сайте www.metec.ee
 • Wenn METEC Produkt nicht Ihren Erwartungen entspricht oder wenn es um Qualitätsmängel geht, dann bitte die Ansprüche auf Seite www.metec.ee einreichen

Lisa / extra / приложение / Extra

